

● BLAUPUNKT

**Autoradio
Sky Line II**

**Dallas MD70
7 640 824 310**

8 622 402 676 Sa 09/00

Ersatzteilliste • Spare Parts List • Liste de rechanges • Lista de repuestos

ME 3420
8 632 094 673



ME 3466
8 632 064 629



ME 1530
8 941 481 074

Mechanische Bauteile
Composants mécaniques





Mechanical parts
Componentes mecánicas

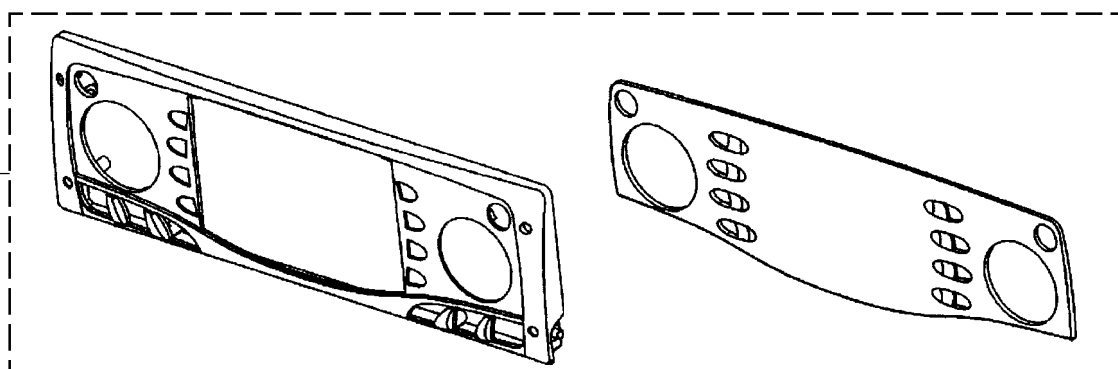

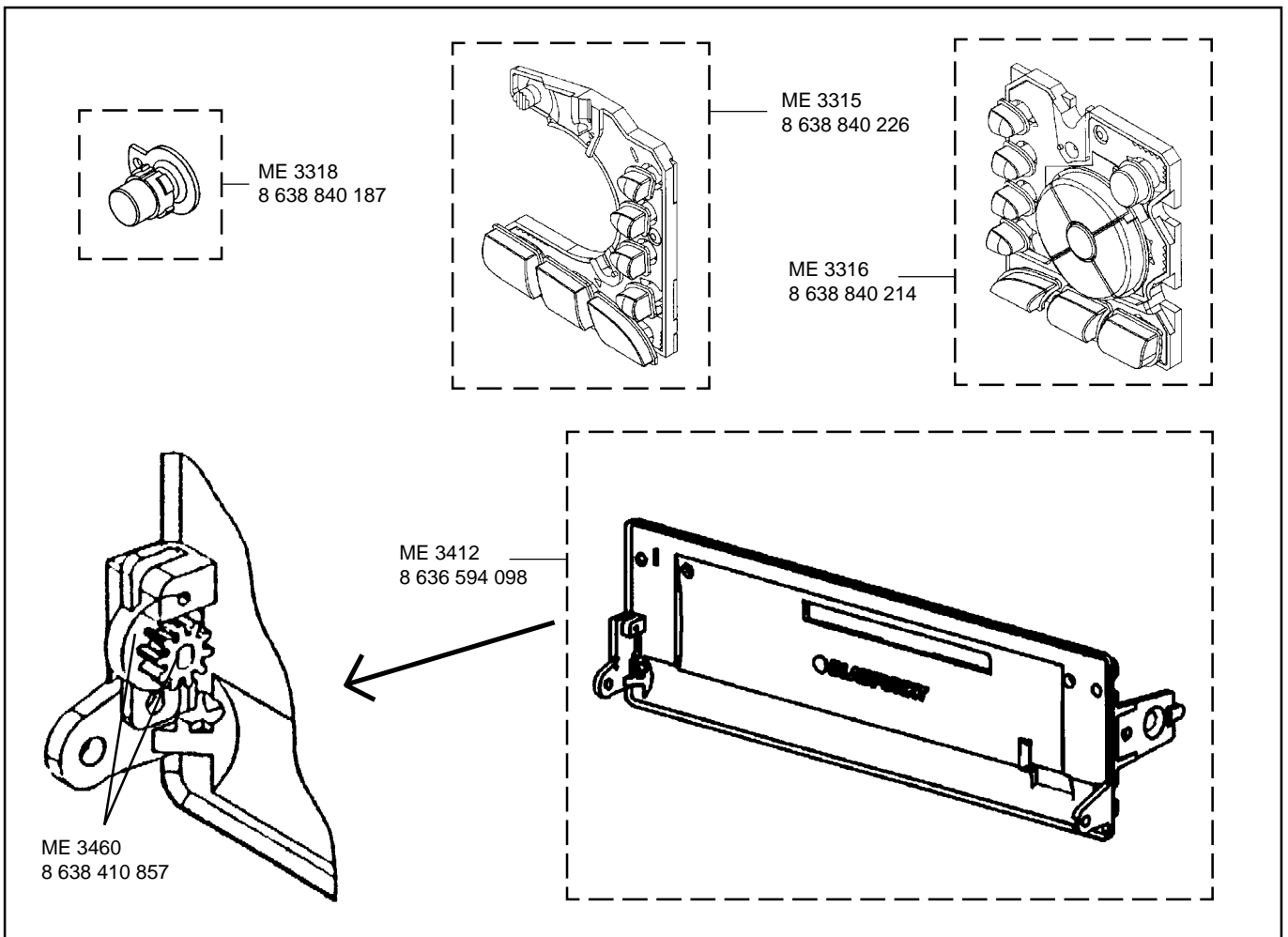
	(D)	(GB)	(F)	(E)	
	ZUBEHÖR	ACCESSORIES	ACCESSOIRES	ACCESORIOS	
ME 1	DEMONTAGEBÜGEL	DISMANTLING AID	ETRIER DE DEMONT.	ESTRIBO DE DESMONT	8 601 910 002
ME 2	ANTENNENSTECKER	ANTENNA PLUG	FICHE D'ANTENNE	CLACIJA D'ANTENA	8 908 603 224
ME 3	BUCHSENHALTER	JACK HOLDER	SUPPORT DE BORNE	SOPORTE DE BORNES	8 600 660 019
ME 4	DISTANZBOLZEN	SPACER PIN	AXE ENTRETOISE	PERNO DISTANCIADOR	8 603 160 008
ME 5	FÜHRUNGSBOLZEN	GUIDE PIN	TIGE DE GUIDAGE	PERNO DE GUIA	8 600 460 050
ME 3901	STYROPOR (2x)	STYROFOAM (2x)	STYROPORE (2x)	STYROPOR (2x)	8 635 460 401
ME 3902	KARTON	CARDBOARD	CARTON	CARTÓN	8 635 432 505
ME 3932	KLEBESCHILD "KEYCARD"	STICKER "KEYCARD"	ETIQUETTE "KEYCARD"	ETIQUETA "KEYCARD"	8 631 110 155
ME 3988	HALTERAHMEN	FRAME	CADRE SUPPORT	MARCO DE FIJACION	8 601 390 742
ME 3990	KEY CARD	KEY CARD	KEY CARD	KEY CARD	8 631 150 150
	GEHÄUSETEILE	HOUSING PARTS	PIÈCES DE LA BOÎTE	PIEZAS EXTERIORES	
ME 1300	MD-LAUFWERK	MD-MECHANISM	LECTEUR DE MD	UNIDAD DE MD	8 638 812 118
ME 1302	FOLIENLEITERBAHN (LW)	FOIL PTD COND. WIRE	CRT IMPRIME	GUIA COND. LAMINAD	8 638 812 200
ME 1670	ANTENNENBUCHSE	ANTENNA SOCKET	DOUILLE D'ANTENNE	CONECTOR DE ANTENA	8 631 391 071
ME 2020	ANSCHLUßKASTEN	TERMINAL BOX	BOITE DE CONNEXION	CAJA DE CONEXIONES	8 634 392 750
ME 2021	SICHERUNG (10A)	FUSE	COUPE-CIRCUIT	CORTACIRCUITO FUSI	8 943 999 001
ME 3140	DECKEL OBEN	TOP COVER	COUVERCLE SUPERIEUR	TAPA SUPERIOR	8 635 132 803
ME 3142	DECKEL UNTEN	BOTTOM COVER	COUVERCLE INFERIEUR	TAPA INFERIOR	8 635 123 164
ME 3550	RASTFEDER (2x)	STOP SPRING (2x)	RESSORT A CRAN (2x)	D'A RESSORTE FIADOR (2x)	8 631 210 500
ME 3845	FOLIENLEITERBAHN	FOIL PTD COND. WIRE	CRT IMPRIME	GUIA COND. LAMINAD	8 638 812 142
	KAPPENHALTER	CAP HOLDER	SUPPORT DE CAPUCHON	SUJETADOR DE TAPAS	
ME 3280	DAEMPfung	DAMPING	AMORTISSEMENT	AMORTIGUACIÓN	8 632 360 735
ME 3280	TORX-SCHRAUBE (1,8x4)	TORX-SCREW	VIS -TORX	TORNILLO-TORX	8 633 410 756
ME 3281	TORX-SCHRAUBE (1,8x12)	TORX-SCREW	VIS -TORX	TORNILLO-TORX	8 633 410 754
ME 3290	DREHFEDER (RASTHAKEN)	TORSION SPRING	RESSORT DE TORSION	RESORTE DE TORSIÓN	8 631 210 592
ME 3490	RASTHAKEN	DROP-IN HOOK	CROCHET D'ARRET	GANCHO DE ENCASTRE	8 631 960 290
	KAPPE	COVER	CAPUCHON	CASQUETE	
ME 3130	RÜCKWAND	REAR PANEL	PANNEAU ARRIERE	PANEL TRASERO	8 636 594 554
ME 3202	TORX-SCHRAUBE (1,8x10) (8x)	TORX-SCREW	VIS -TORX	TORNILLO-TORX	8 633 410 755
ME 3290	DRUCKFEDER	PRESSURE SPRING	RESSORT PRESSION	MUELLE DE COMPRESSION	8 634 620 167
ME 3480	KEYCARD-FÜHRUNG	KEYCARD INSERT	FENTE D'INS. KEYCARD	GULA PARA KEYCARD	8 630 661 130
ME 3555	DREHFEDER	TORSION SPRING	RESSORT DE TORSION	RESORTE DE TORSIÓN	8 631 210 602
ME 3710	LED-PLATTE	LED BOARD	PLAQUE D'LED	PLACA DE LED	8 638 203 750
	SCHALTERPLATTE	SWITCH BOARD	PLAQUE D'INTERRUPT	PLACA COMUTADORA	
ME 1040	LCD	LCD	LCD	LCD	8 945 406 552
ME 1045	LCD-RAHMEN	LCD-FRAME	CADRE LCD	BASTIDOR LCD	8 635 132 818
ME 3330	KONTAKTGUMMI kurz (2x)	CONTACT LEDGE	REGLETTE DE CONTACTS	REGLETA DE CONTACTOS	8 634 360 554
ME 3331	KONTAKTGUMMI lang (1x)	CONTACT LEDGE	REGLETTE DE CONTACTS	REGLETA DE CONTACTOS	8 634 360 552





ME 3402
8 636 594 442







Position Position Position Posición	Bezeichnung Designation Dénomination Denominación	Bestell-Nr. Part no. No. de commande Número de pedido
	SCHALTERPLATTE, SWITCH BOARD, PLAQUE D' INTERRUPT, PLACA DE INTERRUPT	8 638 203 739
		
D 1000	ST 6280BQ6	8 925 904 728
D 1070	LM 224 DR	8 925 900 908
		
H 1004	LB T 776 JK (Blau, blue, bleu, azul)	8 925 405 464
H 1034 -	LO T 776 R1	8 925 406 023
	LO T 776 R2	8 925 406 024
H 1037	LO T 776 S1	8 925 406 041
		
S 1001		8 945 955 945
		
V 910	BC 858 C	8 925 705 039
V 911	BC 848 C	8 925 705 139
V 912	BC 858 C	8 925 705 039
V 981	BC 858 C	8 925 705 039
V 982	LS 4148	8 925 405 324
V 1021	BCP 56-10	8 925 705 225
V 1022	BC 848 C	8 925 705 139
V 1023	BC 848 C	8 925 705 139
V 1025	BC 848 C	8 925 705 139
V 1026	BC 848 C	8 925 705 139
V 1028	BC 848 C	8 925 705 139
V 1029	BC 858 C	8 925 705 039

Position Position Position Posición	Bezeichnung Designation Dénomination Denominación	Bestell-Nr. Part no. No. de commande Número de pedido
		
Z 1001	8 MHz	8 926 193 070
	MECHANISCHE TEILE, MECHANICAL PARTS, COMPOSANTS MÉCANIQUES, COMPONENTES MECÁNICOS	
X 1001	Steckverbindung (Folienleiterbahn), Plug Connection (Foil cond. wire), Connecteur (CRT imprime), Con. por enchu (Guia cond. laminad)	8 638 801 394
X 4900	Kontaktträger (KeyCard), Contact carrier (KeyCard), Porteuse de contact (KeyCard), Portador de contacto (KeyCard)	8 638 801 384
	HAUPTPLATTE, MAIN BOARD, PLAQUETTE PRINCIPALE, PLACA PRINCIPAL	
		
C 2015	3300 µF	8 943 490 388
		
D 1	CF 400C-4	8 925 904 301
D 150	DCR 2SEM	8 925 904 409
D 810	MC 68HC711	8 925 904 735
D 811	CAT 24C08JI	8 925 904 713
D 812	M 92256	8 609 501 252

Position Position Position Posición	Bezeichnung Designation Dénomination Denominación	Bestell-Nr. Part no. No. de commande Número de pedido
D 813	L 4949 EP	8 925 901 447
D 1500	MC 33079 D	8 925 900 205
D 1570	RC 4558	8 925 900 308
D 1600	TDA 7375 A	8 945 903 746
D 1610	TDA 7375 A	8 945 903 746
D 2005	MC 78L05	8 945 902 581
D 2006	L 78S09 CV	8 945 903 291
D 2100	LM 2670 SX-A	8 925 904 436
D 2110	LM 224 DR2	8 925 900 908
		
H 1000	LSM 670 JK	8 925 405 498
		
L 1		8 958 411 133
L 2		8 958 411 006
L 3		8 948 419 052
L 51		8 948 419 042
L 52		8 958 411 000
L 53		8 948 420 013
L 54		8 948 419 042
L 100		8 958 411 165
L 101		8 958 411 166
L 102		8 958 411 165
L 103		8 958 411 166
L 151		8 948 420 013
L 152		8 948 420 013
L 154		8 948 411 013
L 155		8 948 411 013
L 158		8 948 420 013
L 160		8 948 420 013
L 600		8 958 411 106
L 601		8 958 411 155
L 602		8 958 411 152
L 603		8 958 411 152
L 607		8 958 411 198
L 700		8 928 411 060
L 701		8 958 411 016
L 1000		8 958 411 111
L 1001		8 958 411 106
L 2000		8 958 411 006
L 2005		8 948 411 065
L 2010		8 928 411 054
L 2100		8 958 411 183
L 2101		8 958 411 194
L 2102		8 958 411 006
		
R 2002	PTC-Widerstand	8 921 351 000
		
V 1	BB 814	8 925 405 146
V 50	BB 814	8 925 405 146
V 51	BA 885	8 925 405 530
V 52	BF 999	8 925 705 280
V 53	BB 814	8 925 405 146
V 100	BC 848 C	8 925 705 037
V 700	BZX 84C11	8 925 421 093
V 701	BC 848 B	8 925 705 043
V 600	2 SK711BL	8 925 705 176
V 601	1 SV172	8 925 405 318
V 602	Z 47	8 925 421 048
V 610	BAT 18-05	8 925 405 526

Position Position Position Posición	Bezeichnung Designation Dénomination Denominación	Bestell-Nr. Part no. No. de commande Número de pedido
V 611	BAV 70	8 925 405 122
V 612	BF 999	8 925 705 280
V 800	BC 848 C	8 925 705 037
V 803	BAV 99	8 925 405 124
V 814	RLR 4001	8 925 800 044
V 888	BZX 84/C5V1	8 925 421 062
V 1002	BC 848 B	8 925 705 043
V 1011	BC 848 B	8 925 705 043
V 1012	BC 858 B	8 925 705 038
V 1020	LS 4148	8 925 405 324
V 1573	DTC 314 TK	8 925 705 181
V 1600	DTC 314 TK	8 925 705 181
V 1601	DTC 314 TK	8 925 705 181
V 1602	DTC 314 TK	8 925 705 181
V 1603	DTC 314 TK	8 925 705 181
V 1604	BC 858 C	8 925 705 039
V 1605	BAL 99	8 925 405 137
V 1610	BC 848 C	8 925 705 037
V 2000	DTC 143 ZKA	8 925 705 234
V 2007	BD 436	8 945 705 606
V 2010	S 3 G	8 925 405 023
V 2011	BZX 84/C5V1	8 925 421 062
V 2015	1 SR154-400	8 925 405 302
V 2016	BAL 99	8 925 405 137
V 2020	BCX 53-16	8 925 705 137
V 2021	DTC 114EKA	8 925 705 262
V 2050	BC 848 B	8 925 705 043
V 2051	BC 808-25	8 925 705 042
V 2052	BC 808-25	8 925 705 042
V 2100	BYS 10-45	8 925 405 248
V 2101	RLR 4001	8 925 800 044
V 2111	BAW 78 B	8 925 405 177
V 2112	BC 858 C	8 925 705 039
V 2113	LS 4148	8 925 405 324
V 2800	BZT 52/C5V6	8 925 421 076
V 5300	DTA 124 EKA	8 925 705 261
V 5301	BZX 84/C5V6	8 925 421 037
V 5302	BC 848 B	8 925 705 043
V 5303	LS 4148	8 925 405 324
 		
Z 100		8 948 417 034
Z 110		8 926 193 211
Z 150		8 926 193 081
Z 600		8 926 193 048
Z 810		8 926 193 002
MECHANISCHE TEILE, MECHANICAL PARTS, COMPOSANTS MÉCANIQUES, COMPONENTES MECÁNICOS		
X 1001	Steckverbindung (Folienleiterbahn), Plug Connection (Foil cond. wire), Connecteur (CRT imprime), Con. por enchu (Guia cond. laminad)	8 638 801 394
X 5400	Buchsenleiste (MD-Laufwerk), Female connector (MD-Mechanism), Reglette de bornes (Lecteur de MD), Regleta de bornes (Unidad de MD)	8 638 801 338

Explosionszeichnung / Exploded View / Vue éclatée / Dibujo de tipo explosión
MD 2110 8 638 812 118

