

TASCAM

D01142520A

MD-CD1MKIII

Minidisc Deck/CD Player

OWNER'S MANUAL



MDLP

MP3

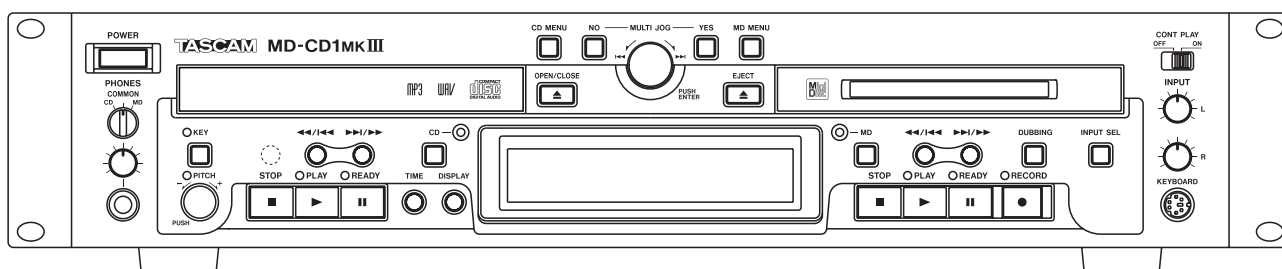

IMPORTANT SAFETY PRECAUTIONS

CAUTION

RISK OF ELECTRIC SHOCK
DO NOT OPEN

CAUTION: TO REDUCE THE RISK OF ELECTRIC SHOCK, DO NOT REMOVE COVER (OR BACK). NO USER-SERVICEABLE PARTS INSIDE. REFER SERVICING TO QUALIFIED SERVICE PERSONNEL.



The lightning flash with arrowhead symbol, within equilateral triangle, is intended to alert the user to the presence of uninsulated "dangerous voltage" within the product's enclosure that may be of sufficient magnitude to constitute a risk of electric shock to persons.



The exclamation point within an equilateral triangle is intended to alert the user to the presence of important operating and maintenance (servicing) instructions in the literature accompanying the appliance.

WARNING: TO PREVENT FIRE OR SHOCK HAZARD, DO NOT EXPOSE THIS APPLIANCE TO RAIN OR MOISTURE.

■ For U.S.A. TO THE USER

This equipment has been tested and found to comply with the limits for a Class A digital device, pursuant to Part 15 of the FCC Rules. These limits are designed to provide reasonable protection against harmful interference when the equipment is operated in a commercial environment. This equipment generates, uses, and can radiate radio frequency energy and, if not installed and used in accordance with the instruction manual, may cause harmful interference to radio communications.

Operation of this equipment in a residential area is likely to cause harmful interference in which case the user will be required to correct the interference at his own expense.

CAUTION

Changes or modifications to this equipment not expressly approved by TEAC CORPORATION for compliance could void the user's authority to operate this equipment.

■ CAUTIONS ABOUT LASER RADIATION

This product has been designed and manufactured according to FDA regulations "title 21, CFR, chapter 1, subchapter J, based on the Radiation Control for Health and Safety Act of 1968," and is classified as a class 1 laser product. There is no hazardous invisible laser radiation during operation because invisible laser radiation emitted inside of this product is completely confined in the protective housings.

The labels required in this regulation are shown at ① and ②.

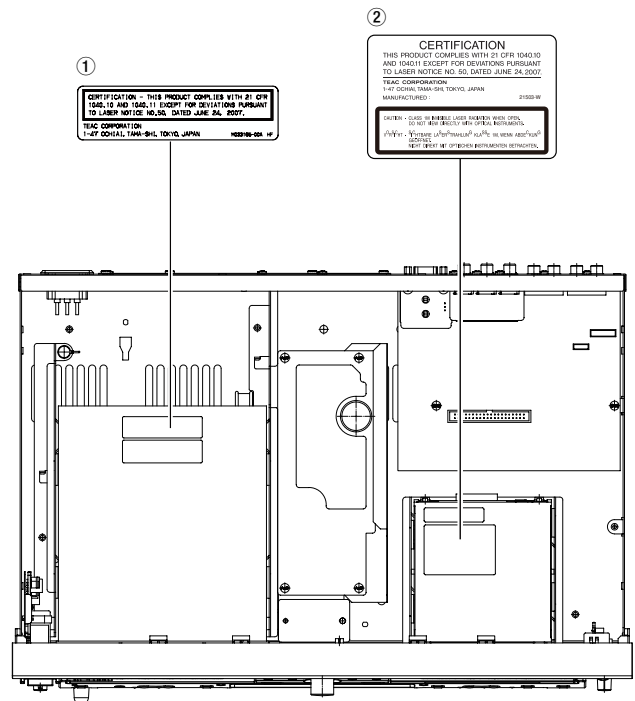

Cautions:

- DO NOT REMOVE THE PROTECTIVE HOUSING USING A SCREWDRIVER.
- USE OF CONTROLS OR ADJUSTMENTS OR PERFORMANCE OF PROCEDURES OTHER THAN THOSE SPECIFIED HEREIN MAY RESULT IN HAZARDOUS RADIATION EXPOSURE.
- IF THIS PRODUCT DEVELOPS TROUBLE, CONTACT YOUR NEAREST QUALIFIED SERVICE PERSONNEL, AND DO NOT USE THE PRODUCT IN ITS DAMAGED STATE.
- CLASS 1M INVISIBLE LASER RADIATION WHEN OPEN AND INTERLOCKS DEFEATED. DO NOT VIEW DIRECTLY WITH OPTICAL INSTRUMENTS.

MD drive optical pickup:

| | |
|--------------|--|
| Type | : HPM-312S |
| Manufacturer | : SHARP CORPORATION |
| Laser output | : Playback 0.6 mW |
| | Recording: According to TOC information. |
| | (Approx. 4.5 mW on MMD-318) |
| Wavelength | : 785 nm |
| Standard | : IEC60825-1 Edition 1.2-2001 |

CD drive optical pickup:

| | |
|--------------|--|
| Type | : SF-P151NVD |
| Manufacturer | : Sanyo Electric Co., Ltd. |
| Laser output | : Less Than 0.2 mW on the objective lens |
| Wavelength | : 790+10/-15 nm |
| Standard | : IEC60825-1: 2007 / EN60825-1:2007 |

IMPORTANT SAFETY INSTRUCTIONS

- 1 Read these instructions.
 - 2 Keep these instructions.
 - 3 Heed all warnings.
 - 4 Follow all instructions.
 - 5 Do not use this apparatus near water.
 - 6 Clean only with dry cloth.
 - 7 Do not block any ventilation openings. Install in accordance with the manufacturer's instructions.
 - 8 Do not install near any heat sources such as radiators, heat registers, stoves, or other apparatus (including amplifiers) that produce heat.
 - 9 Do not defeat the safety purpose of the polarized or grounding-type plug. A polarized plug has two blades with one wider than the other. A grounding type plug has two blades and a third grounding prong. The wide blade or the third prong are provided for your safety. If the provided plug does not fit into your outlet, consult an electrician for replacement of the obsolete outlet.
 - 10 Protect the power cord from being walked on or pinched particularly at plugs, convenience receptacles, and the point where they exit from the apparatus.
 - 11 Only use attachments/accessories specified by the manufacturer.
 - 12 Use only with the cart, stand, tripod, bracket, or table specified by the manufacturer, or sold with the apparatus. When a cart is used, use caution when moving the cart/apparatus combination to avoid injury from tip-over.
- Do not expose this apparatus to drips or splashes.
 - Do not place any objects filled with liquids, such as vases, on the apparatus.
 - Do not install this apparatus in a confined space such as a book case or similar unit.
 - The apparatus draws nominal non-operating power from the AC outlet with its POWER or STANDBY/ON switch not in the ON position.
 - The apparatus should be located close enough to the AC outlet so that you can easily grasp the power cord plug at any time.
 - The mains plug is used as the disconnect device, the disconnect device shall remain readily operable.
 - Products with Class I construction are equipped with a power supply cord that has a grounding plug. The cord of such a product must be plugged into an AC outlet that has a protective grounding connection.
 - If the product uses batteries (including a battery pack or installed batteries), they should not be exposed to sunshine, fire or excessive heat.
 - CAUTION for products that use replaceable lithium batteries: there is danger of explosion if a battery is replaced with an incorrect type of battery. Replace only with the same or equivalent type.
 - Caution should be taken when using earphones or headphones with the product because excessive sound pressure (volume) from earphones or headphones can cause hearing loss.



- 13 Unplug this apparatus during lightning storms or when unused for long periods of time.
- 14 Refer all servicing to qualified service personnel. Servicing is required when the apparatus has been damaged in any way, such as power-supply cord or plug is damaged, liquid has been spilled or objects have fallen into the apparatus, the apparatus has been exposed to rain or moisture, does not operate normally, or has been dropped.

Safety Information

■ For European Customers

CE Marking Information

- a) Applicable electromagnetic environment: E4
- b) Peak inrush current: 11 A

Disposal of electrical and electronic equipment

- (a) All electrical and electronic equipment should be disposed of separately from the municipal waste stream via collection facilities designated by the government or local authorities.
- (b) By disposing of electrical and electronic equipment correctly, you will help save valuable resources and prevent any potential negative effects on human health and the environment.
- (c) Improper disposal of waste electrical and electronic equipment can have serious effects on the environment and human health because of the presence of hazardous substances in the equipment.
- (d) The Waste Electrical and Electronic Equipment (WEEE) symbol, which shows a wheeled bin that has been crossed out, indicates that electrical and electronic equipment must be collected and disposed of separately from household waste.



- (e) Return and collection systems are available to end users. For more detailed information about the disposal of old electrical and electronic equipment, please contact your city office, waste disposal service or the shop where you purchased the equipment.

Disposal of batteries and/or accumulators

- (a) Waste batteries and/or accumulators should be disposed of separately from the municipal waste stream via collection facilities designated by the government or local authorities.
- (b) By disposing of waste batteries and/or accumulators correctly, you will help save valuable resources and prevent any potential negative effects on human health and the environment.
- (c) Improper disposal of waste batteries and/or accumulators can have serious effects on the environment and human health because of the presence of hazardous substances in them.
- (d) The WEEE symbol, which shows a wheeled bin that has been crossed out, indicates that batteries and/or accumulators must be collected and disposed of separately from household waste.



If a battery or accumulator contains more than the specified values of lead (Pb), mercury (Hg), and/

or cadmium (Cd) as defined in the Battery Directive (2006/66/EC), then the chemical symbols for those elements will be indicated beneath the WEEE symbol.

- (e) Return and collection systems are available to end users. For more detailed information about the disposal of waste batteries and/or accumulators, please contact your city office, waste disposal service or the shop where you purchased them.

WARNING

This is a Class A product. In a domestic environment, this product may cause radio interference in which case the user may be required to take adequate measures.

■ RACK-MOUNTING THE UNIT

Use the supplied rack-mounting kit to mount the unit in a standard 19-inch rack, as shown below.

Remove the feet of the unit before mounting.

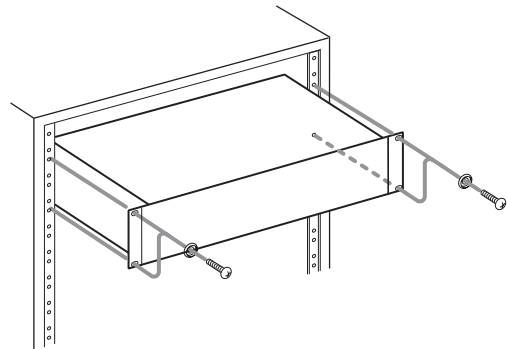

NOTE

- Leave 1U of space above the unit for ventilation.
- Allow at least 10 cm (4 in) at the rear of the unit for ventilation.

This appliance has a serial number located on the top panel. Please record the model number and serial number and retain them for your records.

Model number _____

Serial number _____

■ CAUTIONS ABOUT BATTERIES

This product uses batteries. Misuse of batteries could cause a leak, rupture or other trouble. Always abide by the following precautions when using batteries.

- Never recharge non-rechargeable batteries. The batteries could rupture or leak, causing fire or injury.
- When installing batteries, pay attention to the polarity indications (plus/minus (+/-) orientation), and install them correctly in the battery compartment as indicated. Putting them in backward could make the batteries rupture or leak, causing fire, injury or stains around them.
- When you store or dispose of batteries, isolate their terminals with insulation tape or something like that to prevent them from contacting other batteries or metallic objects.
- When throwing used batteries away, follow the disposal instructions indicated on the batteries and the local disposal laws.
- Do not use batteries other than those specified. Do not mix and use new and old batteries or different types of batteries together. The batteries could rupture or leak, causing fire, injury or stains around them.
- Do not carry or store batteries together with small metal objects. The batteries could short, causing leak, rupture or other trouble.
- Do not heat or disassemble batteries. Do not put them in fire or water. Batteries could rupture or leak, causing fire, injury or stains around them.
- If the battery fluid leaks, wipe away any fluid on the battery case before inserting new batteries. If the battery fluid gets in an eye, it could cause loss of eyesight. If fluid does enter an eye, wash it out thoroughly with clean water without rubbing the eye and then consult a doctor immediately. If the fluid gets on a person's body or clothing, it could cause skin injuries or burns. If this should happen, wash it off with clean water and then consult a doctor immediately.
- The unit power should be off when you install and replace batteries.
- Remove the batteries if you do not plan to use the unit for a long time. Batteries could rupture or leak, causing fire, injury or stains around them. If the battery fluid leaks, wipe away any fluid on the battery compartment before inserting new batteries.
- Do not disassemble a battery. The acid inside the battery could harm skin or clothing.

For China

产品有毒有害物质或元素的名称及含量

| 机种：MD-CD1MKIII | | 有毒有害物质或元素 | | | | | |
|----------------|-----------------|-----------|--------|--------|---------------|------------|--------------|
| | 品名 | 铅 (Pb) | 汞 (Hg) | 镉 (Cd) | 六价铬 (Cr (VI)) | 多溴联苯 (PBB) | 多溴二苯醚 (PBDE) |
| 1 | CHASSIS部份 | ○ | ○ | ○ | ○ | ○ | ○ |
| 2 | CD DRIVE UNIT部份 | × | ○ | ○ | ○ | ○ | ○ |
| 3 | FRONT PANEL部份 | ○ | ○ | ○ | ○ | ○ | ○ |
| 4 | MD DRIVE UNIT部份 | ○ | ○ | ○ | ○ | ○ | ○ |
| 5 | PCB Assy部份 | × | ○ | ○ | ○ | ○ | ○ |
| 6 | 电源部份 | ○ | ○ | ○ | ○ | ○ | ○ |
| 7 | 线材部份 | ○ | ○ | ○ | ○ | ○ | ○ |
| 8 | 螺丝部份 | × | ○ | ○ | ○ | ○ | ○ |
| 9 | 附属品部份 | ○ | ○ | ○ | ○ | ○ | ○ |
| 10 | SEAL部份 | ○ | ○ | ○ | ○ | ○ | ○ |
| 11 | 包装部分 | ○ | ○ | ○ | ○ | ○ | ○ |

○：表示该有毒有害物质在该部件所有均质材料中的含量均在 SJ/T11363-2006 标准规定的限量要求以下。
 ×：表示该有毒有害物质至少在该部件的某一均质材料中的含量超出 SJ/T11363-2006 标准规定的限量要求。
 （针对现在代替技术困难的电子部品及合金中的铅）

Contents

| | | | |
|--|-----------|---|-----------|
| 1 – Introduction | 8 | About the monitor | 27 |
| Features | 8 | Using headphones..... | 27 |
| Included items | 9 | COMMON output..... | 27 |
| About this manual | 9 | Display master and remote master settings | 27 |
| Trademarks..... | 9 | Track selection | 27 |
| Precautions for placement and use..... | 9 | Using the skip function | 27 |
| Connecting the power | 10 | Selecting by track number | 27 |
| Cleaning the unit..... | 10 | Search..... | 27 |
| Beware of condensation..... | 10 | Time Search function | 28 |
| About compact discs..... | 10 | Basic operation | 28 |
| Handling of compact discs | 10 | Operation variations | 28 |
| Handling of MDs | 10 | Auto cue | 28 |
| About the User Table of Contents (U-TOC)..... | 11 | Auto Ready | 28 |
| 2 – Remote Control Unit..... | 12 | Repeat playback..... | 29 |
| Preparation of Remote Control Unit | 12 | A to B repeat playback | 29 |
| Inserting batteries..... | 12 | Continuous CD and MD playback..... | 29 |
| When to replace the batteries..... | 12 | Timer Playback..... | 29 |
| Precautions about using batteries..... | 12 | Pitch control (CD only) | 30 |
| Precautions about using the remote control... 12 | | Single-track playback | 30 |
| 3 – Connections..... | 13 | Program playback..... | 30 |
| Audio equipment..... | 13 | Deleting a programmed track..... | 31 |
| Power source | 13 | Adding a track to the program..... | 31 |
| 4 – Names and Functions of Parts | 14 | Erase a CD or MD program | 31 |
| Front panel | 14 | Program limitations..... | 31 |
| Shared features | 14 | Saving program data | 31 |
| CD Operation..... | 15 | Random playback | 31 |
| MD Operation..... | 16 | Time display switching | 32 |
| Display..... | 17 | End of disc/track warning..... | 32 |
| Rear Panel | 18 | Playback functions for CD only | 32 |
| Remote Control Unit..... | 19 | Changing the key of playback..... | 32 |
| CD Operation Section..... | 20 | Fade-in and fade-out..... | 32 |
| MD Operation Section | 21 | Output volume..... | 33 |
| 5 – Display Master and Remote Control | | MP3 and WAV file directory playback..... | 33 |
| Master | 22 | Directory playback setting | 33 |
| Selecting the remote control master..... | 22 | Setting MP3 ACTION..... | 33 |
| Selecting the display master..... | 22 | MD group playback..... | 34 |
| 6 – Menu Operation | 23 | Group playback setting | 34 |
| Menu configuration | 23 | 8 – Dubbing from CD to MD | 35 |
| CD Menu..... | 23 | Basic dubbing operation..... | 35 |
| MD Menu..... | 24 | Recording mode setting | 35 |
| Operation basics | 25 | Dubbing speed setting..... | 35 |
| 7 – CD and MD Playback..... | 26 | 9 – MD recording from an external source . | 36 |
| Discs for playback | 26 | Basic recording | 36 |
| Playback modes..... | 26 | Recording cautions | 37 |
| Basic playback operation | 26 | Update (Move up) a track number..... | 37 |
| | | Auto track function..... | 37 |
| | | Update a track number manually | 37 |

| | | | |
|--|-----------|---|-----------|
| Update a track number after recording..... | 37 | Copy control CD discs..... | 50 |
| Fade-in and fade-out recording..... | 38 | MD section..... | 50 |
| Prerecording (Time Machine recording)..... | 38 | 16 – Messages and Troubleshooting..... | 52 |
| Overwrite recording..... | 38 | 17 – Specifications..... | 53 |
| Sync recording..... | 39 | MD deck..... | 53 |
| Checking remaining MD time..... | 39 | CD deck..... | 53 |
| 10 – MiniDisc editing..... | 40 | Input ratings (MD inputs)..... | 53 |
| Editing operations..... | 40 | Output ratings..... | 53 |
| Tracks and points for editing..... | 40 | Control I/O..... | 54 |
| Canceling edits..... | 40 | Audio performance..... | 54 |
| UNDO an edit operation (UNDO function)..... | 40 | General..... | 54 |
| Erase disc (ERASE DISC)..... | 40 | Dimensional drawing..... | 54 |
| Erase track (ERASE TRK)..... | 40 | | |
| Selecting a track to be erased by playback..... | 40 | | |
| Selecting a track to be erased on the menu..... | 40 | | |
| Erase multiple tracks at once (ERASE MULTI)..... | 41 | | |
| Divide tracks (DIVIDE)..... | 41 | | |
| Combine tracks (COMBINE)..... | 42 | | |
| Move tracks (MOVE)..... | 42 | | |
| Creating a group..... | 42 | | |
| Disc title when creating a group..... | 43 | | |
| Deleting a group..... | 43 | | |
| 11 – Title input..... | 44 | | |
| Disc title input (TITLE)..... | 44 | | |
| Title input operation..... | 44 | | |
| Track title input..... | 44 | | |
| Group title input..... | 45 | | |
| 12 – Using a Computer Keyboard..... | 46 | | |
| Keyboard type setting..... | 46 | | |
| Title input by keyboard..... | 46 | | |
| Other keyboard operations..... | 46 | | |
| Direct track operation..... | 47 | | |
| 13 – Locking the panel operations..... | 48 | | |
| Locking the entire panel..... | 48 | | |
| Locking individual decks..... | 48 | | |
| 14 – Data settings/Service Data..... | 49 | | |
| Data communication settings..... | 49 | | |
| Viewing service data..... | 49 | | |
| Initializing all data..... | 49 | | |
| 15 – System Limitations..... | 50 | | |
| CD section..... | 50 | | |
| About MP3 and WAV files..... | 50 | | |
| About CD-R/RW..... | 50 | | |

1 – Introduction

Thank you very much for purchasing the TASCAM MD-CD1MKIII MiniDisc Deck and CD Player.

Before connecting and using the unit, please take time to read this manual thoroughly to ensure you understand how to properly set up and connect the unit, as well as the operation of its many useful and convenient functions. After you have finished reading this manual, please keep it in a safe place for future reference.

You can also download the Owner's Manual from the TASCAM web site (<http://tascam.com/>).

Features

- Equipped with an MD recorder and a CD player in a 2U rack mount size
- The MD recorder and a CD player can be operated separately.
- In addition to audio CDs, MP3 and WAV files (44.1 kHz, 16 bit) recorded on a CD-R, CD-RW, or CD-ROM can be played back.
- Compatible with four MD modes (STEREO, MONO, LP2, and LP4). Also, you can record and play back files on an MD with different modes.
- A pitch control function with a range of -50% to +16% (audio CD only). You can adjust the pitch between 0.1 and 1.0% in 0.1% increments.
- You can adjust a key with a range of ♭6 to #6 in semitone units without changing the playback speed. (Audio CD only)
- Auto cue function – The unit searches for the beginning of a sound and the playback is put on standby. (Adjusting range: by 6 dB between -72 and -24dB)
- Auto ready function – After playing back a track, the playback of the next track is put on standby.
- Synchronized recording by input audio signal function (MD only)
- Pre-recording (“Time machine” recording) function (MD only, time can be adjusted in one second increments between one and six seconds).
- Up to 100 discs worth of tracks (CD and MD) can be programmed in the program memory.
- Panel lock function
- Compatible with CD-TEXT (While the playback is stopped: The disc title is displayed/While the playback is in progress: The track title is displayed)
- Compatible with ID3 tag (only for a CD containing MP3 files)
- Four playback modes for CD, and five for MD – Continuous, Single, Program (up to 99 tracks for CD/25 tracks for MD), Random, and Group (MD only)
- Five repeat playback modes - Normal, Single, Program (up to 99 tracks for CD/25 tracks for MD), Random, and A to B
- Equipped with a digital volume control for CD output (-∞ and between -54 to +18 dB)
- Fade-in/fade-out playback function (CD only, one second increment between one and 30 seconds)
- EOM function – A warning for the end of the track or disc is displayed. (Audio CD and MD, time can be adjusted in one second increments between one and 99 seconds.)
- Time search function – The track and the playback starting point can be specified using the number keys on the remote control.
- Power-on play function
- Four time display modes – Elapsed/remaining track time and Elapsed/remaining disc time (Only elapsed track time is available for MP3/WAV files.)
- Function for erasing discs/tracks, dividing/combining/moving tracks, and editing titles (MD only)
- Compatible with group creation and group playback (MD only)
- Overwrite recording function – Recording a new signal over a recorded portion (MD only)
- Automatic track increment by input level detection or by track information from an S/PDIF input (MD only)
- Manual track increment by pressing the RECORD button during recording (MD only)
- Input monitor function (MD only)
- Equipped with digital volume (-∞ and between -54 and +18 dB) and analog volume (left/right independent) for input signals (MD only)
- Fade-in/fade-out recording function (one second increments between one and 30 seconds: MD only)
- Dubbing from a CD to an MD (entire disc or individual tracks)
- Dubbing a track title from CD-TEXT or ID3 tags automatically
- Fade-in/Fade-out dubbing function
- Successive playback of MD and CD (playing back an entire disc alternately and repeatedly)
- Wireless remote control (supplied)
- RS-232C serial remote control function
- Compatible with a balanced I/O card (TASCAM LA-MC1: separately purchased)
- Unbalanced analog input/output (RCA) (Input: MD x 1, Output: MD x 1, CD x 1)
- S/PDIF optical digital input/output (Input: MD x 1, Output: MD x 1, CD x 1) (SCMS)
- S/PDIF coaxial digital input/output (Input: MD x 1, Output: MD x 1, CD x 1) (SCMS)
- Remote control possible from a PS/2 keyboard (You can edit MD or enter a track title from the keyboard.)
- Common output terminal to output both CD and MD sound (You can select the output priority.)
- Headphone output (Selectable from MD, CD, or common)

Included items

The included items are listed below.

Take care when opening the package not to damage the items. Keep the package materials for transportation in the future.

Please contact the store where you purchased this unit if any of these items are missing or have been damaged during transportation.

- Main unit 1
- Power cord 1
- Wireless remote control (TASCAM RC-MC1) 1
- AA batteries for the remote control unit 2
- A rack-mounting screw kit 1
- A warranty card 1
- Owner's manual (this manual) 1

NOTE

The batteries are not supplied for Taiwan.

About this manual

In this manual, we use the following conventions:

- "MiniDisc" is abbreviated as "MD."
- The names of buttons and controls are given in the following typeface: **STOP**.
- Messages on the unit's display are shown like this:
REPEAT
- When the character display area shows information about discs and tracks this is called the "information display" mode.
- CDs on which MP3 or WAV audio files are recorded may be mentioned as "data CDs".
- Additional information is introduced in the styles below when needed:

TIP

Useful hints when using the unit.

NOTE

Explanation of actions in special situation and supplement.

CAUTION

Instructions that should be followed to avoid injury, damage to the unit or other equipment, and loss of data.

Trademarks

- TASCAM is a trademark of TEAC Corporation, registered in the U.S. and other countries.
- US and foreign patents licensed from Dolby Laboratories Licensing Corporation.
- MPEG Layer-3 audio coding technology licensed from Fraunhofer IIS and Thomson.
- Other company names, product names and logos in this document are the trademarks or registered trademarks of their respective owners.

Any data, including, but not limited to information, described herein are intended only as illustrations of such data and/or information and not as the specifications for such data and/or information. TEAC Corporation disclaims any warranty that any use of such data and/or information shall be free from infringement of any third party's intellectual property rights or other proprietary rights, and further, assumes no liability of whatsoever nature in the event of any such infringement, or arising from or connected with or related to the use of such data and/or information.

This product is designed to help you record and reproduce sound works to which you own the copyright, or where you have obtained permission from the copyright holder or the rightful licensor. Unless you own the copyright, or have obtained the appropriate permission from the copyright holder or the rightful licensor, your unauthorized recording, reproduction or distribution thereof may result in severe criminal penalties under copyright laws and international copyright treaties. If you are uncertain about your rights, contact your legal advisor. Under no circumstances will TEAC Corporation be responsible for the consequences of any illegal copying performed using the recorder.

Precautions for placement and use

- The operating temperature should be between 5°C and 40°C (41°F and 104°F).
- Do not install in the following types of places. Doing so could degrade the sound quality and/or cause malfunctions.
 - Places with significant vibrations or that are otherwise unstable
 - Near windows or other places exposed to direct sunlight
 - Near heaters or other extremely hot places
 - Extremely cold places

1 – Introduction

- Places with bad ventilation or high humidity
- Very dusty locations
- Make sure that the unit is mounted in a level position for correct operation.
- Do not place any object on the unit for heat dissipation.
- Avoid installing this unit on top of any heat-generating electrical device such as a power amplifier.

Connecting the power

- Hold the power cord by the plug when connecting or disconnecting it.
- Insert the included power cord into the **AC IN** connector completely.

Cleaning the unit

To clean the unit, wipe it gently with a soft dry cloth. Do not wipe with chemical cleaning cloths, benzene, paint thinner, ethyl alcohol or other chemical agents to clean the unit as they could damage the surface.

Beware of condensation

If the unit is moved from a cold to a warm place, or used immediately after a cold room has been heated or otherwise exposed to a sudden temperature change, condensation could occur. Should this happen, leave the unit for one or two hours before turning the unit on.

About compact discs

In addition to audio CDs (CD-DA), the unit can play CD-R and CD-RW discs on which audio CD, MP3, or WAV format files are recorded. The CD player can also play 3-inch CDs.

Handling of compact discs

- Always place the compact discs in the trays with their label facing upward.
- To remove a disc from its case, press down on the center of the disc holder, then lift the disc out, holding it carefully by the edges.
- Avoid getting fingerprints on the signal side (the non-label side). Grime and dust may cause skipping or malfunction.
- To clean the signal side of a disc, wipe gently with a soft dry cloth from the center towards the outside edge. Dirt on discs can lower the sound quality, so clean them and always store them in a clean state.
- Do not use any record spray, anti-static solutions, benzene, paint thinner or other chemical agents to

clean CDs as they could damage the delicate playing surface. It may cause CDs to become unplayable.

- Do not affix any labels or stickers to the label side of the disc and do not use any protective coating spray. Do not insert discs that have adhesive remaining from tape or stickers that have been removed. If they are inserted into the player, they could stick to the internal mechanism, requiring removal by a technician.
- Never use a commercially available CD stabilizer. Using stabilizers with this player will damage the mechanism and cause it to malfunction.
- Do not use cracked discs.
- Only use circular compact discs. Avoid using non-circular promotional, etc. discs.

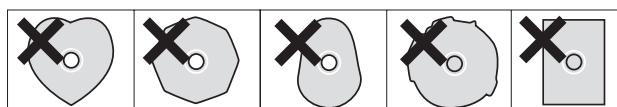

- Music discs with copy control, a copy-protection system, have been released from several record companies in an attempt to protect the copyright. Since some of these discs do not comply with the CD specifications, they may not be playable on the unit.

Handling of MDs

The MD itself is mounted inside a cartridge. Soiling or warping of the cartridge could cause malfunction.

To ensure continued enjoyment of the contents of an MD, please observe the following precautions.

- After use, always return an MD to its case.
- Do not open the shutter and touch the disc inside. Moreover, forcing the shutter open could break the MD.
- Keep discs out of direct sunlight and places of high heat and humidity.
- Wipe dirt and grime from the cartridge surface with a dry cloth.
- When applying labels to an MD, apply them correctly to the indicated locations. Loose or raised labels could cause an MD to become stuck in the unit.
- Do not layer labels on top of other labels.

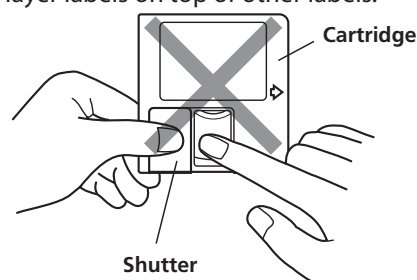

About the User Table of Contents (U-TOC)

Recorded tracks on a recordable MD can be edited. Information about recorded tracks, including their starting and ending addresses and titles, is recorded in something called the User Table of Contents (U-TOC). This is overwritten when the disc is edited.

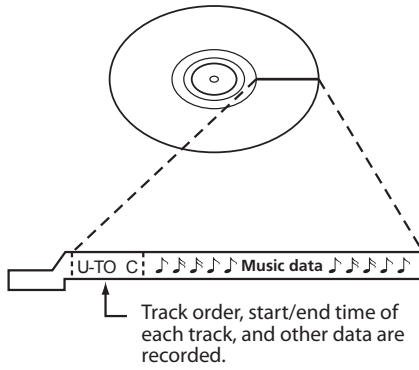

2 – Remote Control Unit

Preparation of Remote Control Unit

Inserting batteries

- 1 Open the cover on the back of the remote control.

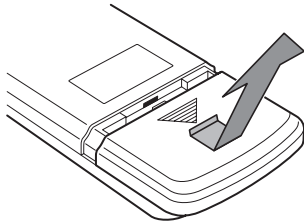

- 2 Insert two AA batteries with the correct \pm orientations.

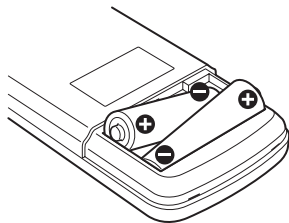

- 3 Close the cover.

NOTE

The batteries are not supplied for Taiwan.

When to replace the batteries

Replace both batteries with new ones when the range of the remote control becomes short or if the buttons become unresponsive.

Precautions about using batteries

Misuse of batteries could cause them to leak, rupture or otherwise be damaged. Please read and abide by the precautions on the battery labels when using them. See page 5 of this manual for additional precautions.

Precautions about using the remote control

- When using other devices controlled by infrared rays, use of this remote control might operate these devices by mistake.
- Use the remote control within the following range.

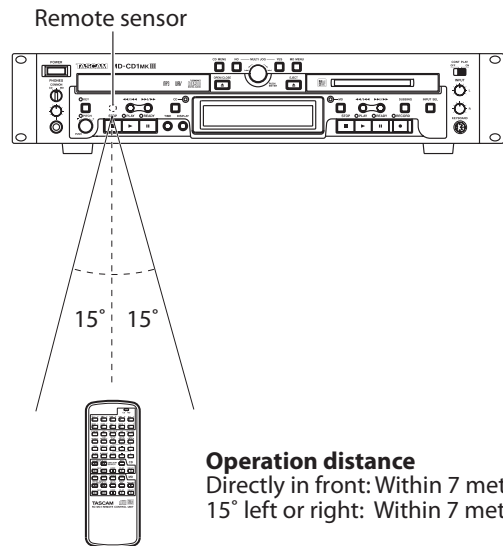

Operation distance
Directly in front: Within 7 meters
15° left or right: Within 7 meters

Before connecting the MD-CD1MKIII to other units, please read their operation manuals thoroughly to ensure proper connection. Connect the power cord only after all connections have been made.

Audio equipment

■ Connecting analog audio equipment

Connect analog stereo amplifiers, mixers and recorders to the analog line inputs and outputs. There are input terminals for the MD deck recording source and terminals for both the CD and MD outputs, as well as a COMMON output for the output signals of the CD deck, the MD deck, or both. Selection of either deck's output signals can be performed on the SYSTEM sub-menu of the CD menu under the "COMMON?" option.

NOTE

- You can use this unit in a system configured with balanced analog input/output only by attaching a separately sold balanced analog input/output board (TASCAM LA-MC1).
- Connection cables are not supplied with this unit.
- Do not bundle the line level sound signal cables with the power or speaker cords as noise or diminished sound quality could result.

■ Connecting digital audio equipment

Digital stereo amplifiers, mixers and recorders can be connected through the digital input/output terminals (optical or coaxial).

NOTE

The MD-CD1MKIII features a sampling rate converter, which enables you to digitally record signals not only at a sampling rate of 44.1 kHz (a sampling rate for MD), but also at sampling rates of 32 kHz or 48 kHz.

Power source

This unit has been designed to operate on the specified power voltage only. Do not plug the power cord into outlets of any other voltage.

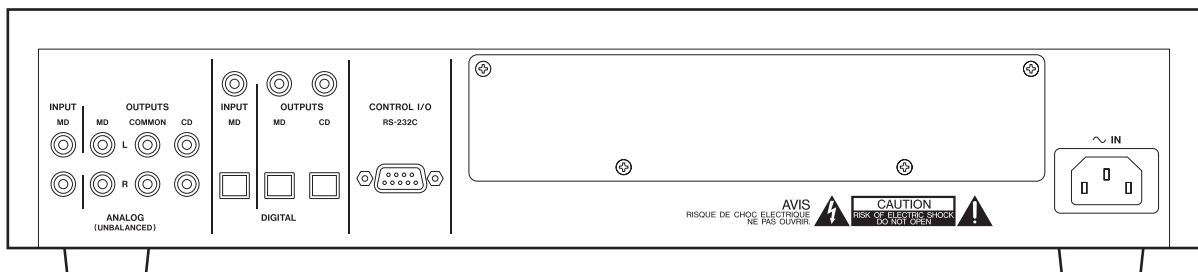

4 – Names and Functions of Parts

Front panel

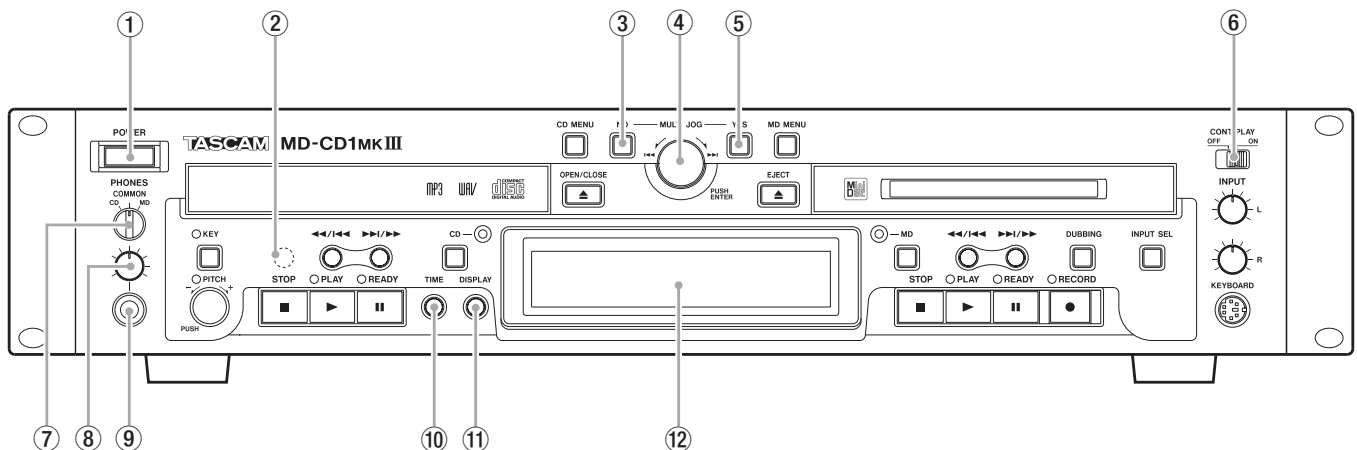

Shared features

① Power switch

Press to turn the power on and off.

CAUTION

Before turning the power on, minimize the volume of other equipment that is connected to this unit. Failure to do so might cause sudden loud noises, which could harm your hearing or result in other trouble.

② Remote signal sensor

Receives signals from the supplied wireless remote control (TASCAM RC-MC1). When using the remote control, point the tip at this sensor.

③ NO button

Used to cancel menu operations during menu mode. During title input mode, it is used to delete character inputs

④ MULTI JOG dial/ENTER button

Functions as the **MULTI JOG** dial when rotated, and as the **ENTER** button when pushed

MULTI JOG dial functions

Normal mode: selection of MD disc groups (when **MD** indicator is lit and group playback mode is ON) or selection of data CD directories (when **CD** indicator is lit)

Program mode: selection of recorded tracks

Menu mode: selection of menu options and their settings

MD Edit mode: selection of editing points

Title input mode: character input selection

In any mode other than those listed above, the dial performs the display master deck's Track Skip function.

ENTER button functions

Program mode: confirmation of selected tracks

Menu mode: confirmation of menu options and confirmation of settings and editing on the menu (works the same as the **YES** button)

Title input mode: confirmation of selected characters

⑤ Yes button

Menu mode: confirmation of menu options and confirmation of settings and editing on the menu
Title input mode: inserts characters

⑥ CONT PLAY switch

When ON, the CD and MD decks play successively. The deck currently in playback automatically becomes the display master.

⑦ PHONES source selection switch

During headphone monitoring, **CD**, **COMMON** or **MD** can be selected as the source. When **COMMON** is selected, the current output (either CD or MD) can be monitored. When both decks output a signal, the monitored source depends on the "COMMON?" option setting on the SYSTEM menu.

⑧ PHONES level control

Adjusts the headphone output level.

⑨ PHONES jack

This is a standard stereo jack for stereo headphone connection. When using headphones with a stereo mini plug, an adaptor is required.

⑩ TIME button

Pressing this button changes the time mode on the display. Refer to "Time display switching" on page 32. Even when the power is turned off, the time mode is retained.

⑪ Display button

Used to select input character type during Title Input mode. Refer to "Title input" on page 44.

The type of character selected is indicated by the display.

Lower case letters/code: no indication

Capital letters/code: **CAPS**

Japanese: **カタカナ**

⑫ Display

CD and MD data, deck operation mode, menus and other information are shown on the display. For details, refer to "Display" on page 17.

4 – Names and Functions of Parts

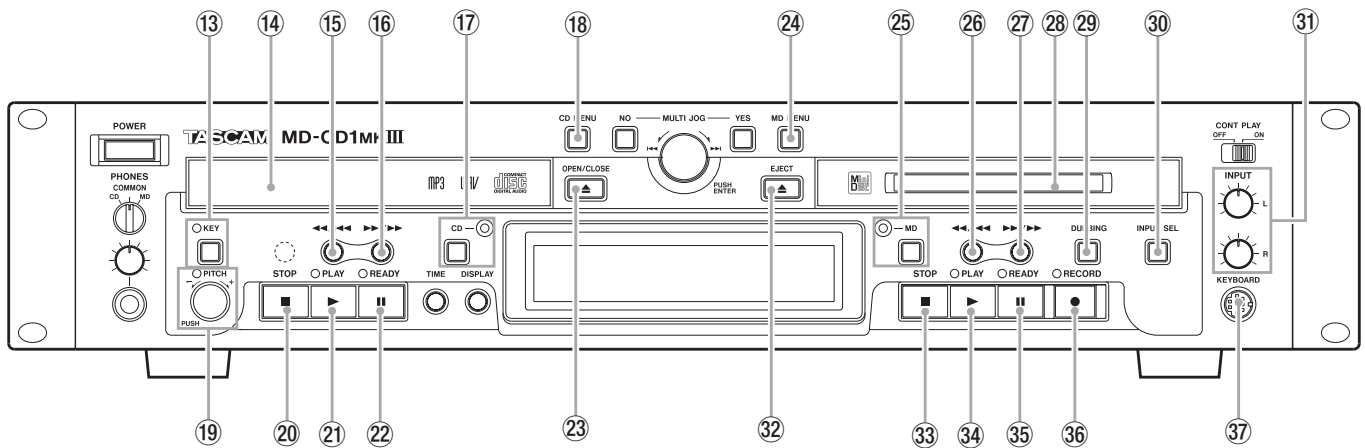

CD Operation

13 KEY button / Indicator

When this button is pressed, the Indicator light goes on and the Key Change function is turned on, allowing you to change the musical key of Compact Disc playback.

Refer to “Changing the key of playback” on page 32.

Even when the power is turned off, the key change setting is retained.

14 CD Tray

Compact Discs are placed here for loading.

15 ◀◀/|◀◀ button

In normal mode, this button is used to skip back a track or for review playback (search).

When playback is stopped, if this button is pressed once, the previous track is selected; if it is pressed continuously, the tracks are skipped backward at high speed.

During playback, if this button is pressed once, the beginning of the current track is cued, and playback restarts; if it is pressed continuously, review playback (search) is performed.

16 ▶▶/|▶▶ button

In normal mode, this button is used to skip forward a track or for cue playback (search).

When playback is stopped, if this button is pressed once, the next track is selected; if it is pressed continuously, the tracks are skipped forward at high speed.

During playback, if this button is pressed once, the beginning of the next track is cued, and playback begins; if it is pressed continuously, cue playback (search) is performed.

17 CD button/indicator

When this button is pressed, the indicator goes on, CD becomes the display master, and CD deck and disc information (such as settings and time) are shown on the display.

Even when the power is turned off, the display master setting is retained.

18 CD MENU button

This turns the CD Menu mode on or off. In CD Menu mode, the **CD** indicator light flashes, CD menu options are indicated on the display, and settings can be performed.

NOTE

- If the **CD MENU** button is pressed when the display master is MD, the **MD** indicator stays lit, while the **CD** indicator flashes.
 - If the **CD MENU** button is pressed when the display master is CD (**CD** indicator ON), the **CD** indicator will begin flashing.
- 19 **PITCH Control/Indicator**
Push this control to turn the pitch control function on or off. When it is on, the indicator lights up, and pitch can be adjusted between -50% and +16% by turning the control. Even when the power is turned off, the pitch control ON/OFF setting is retained.
- 20 **STOP (■) button**
During CD playback, press this button to stop playback. When this button is pressed during dubbing operation, both the MD and CD decks stop simultaneously.
- 21 **PLAY (▶) button**
Press this button to start CD playback when the CD deck is in stop or standby mode.
When this button is pressed during dubbing standby mode, the CD deck starts playback, the MD deck starts recording, and dubbing begins.
- 22 **READY (||) button**
When this button is pressed during playback or while stopped, the CD deck enters standby mode.
- 23 **OPEN/CLOSE (▲) button**
Press this button to open or close the CD tray.

4 – Names and Functions of Parts

MD Operation

24 MD MENU button

This turns the MD Menu mode on or off. In MD Menu mode, the **MD** indicator flashes, MD Menu options are indicated on the display, and settings can be performed.

NOTE

- If the **MD MENU** button is pressed when the display master is CD, the **CD** indicator stays lit, while the **MD** indicator flashes.
- If the **MD MENU** button is pressed when the display master is MD (**MD** indicator ON), the **MD** indicator will begin flashing.

25 MD button/indicator

When this button is pressed, the indicator goes on, MD becomes the display master, and MD deck and disc information (such as settings and time) are shown on the display. Even when the power is turned off, the display master setting is retained.

26 ◀◀/|◀◀ button

In normal mode, this button is used to skip back a track or for review playback (search).

When playback is stopped, if this button is pressed once, the previous track is selected; if it is pressed continuously, the tracks are skipped backward at high speed.

During playback, if this button is pressed once, the beginning of the current track is cued, and playback restarts; if it is pressed continuously, review playback (search) is performed.

During Title Input mode, this button is used to move the cursor to the left.

27 ▶▶/|▶▶ button

In normal mode, this button is used to skip forward a track or for cue playback (search).

When playback is stopped, if this button is pressed once, the next track is selected; if it is pressed continuously, the tracks are skipped forward at high speed.

During playback, if this button is pressed once, the beginning of the next track is cued, and playback begins; if it is pressed continuously, cue playback (search) is performed.

During Title Input mode, this button is used to move the cursor to the right.

28 MD slot

Insert a MiniDisc here for playback or recording. With the label side up, insert in the direction of the arrow.

29 DUBBING button

This is used when dubbing from CD to MD. For details, see "Dubbing from CD to MD" on page 35.

30 INPUT SEL button

Select a recording source for the MD deck. The source changes in the following order each time the key is pressed:

ANALOG → OPTICAL → COAXIAL

During Dubbing mode, the CD output signal is automatically selected as the source.

Even when the power is turned off, the input source selection is retained.

31 INPUT (L/R) controls

These controls are used to adjust the input level when recording analog signals to MD. The left and right channels may be independently controlled.

32 EJECT (▲) button

Press this to eject the MD.

33 STOP (■) button

Press this button to stop MD playback or recording.

If this button is pressed during dubbing, the MD deck and the CD player stop simultaneously.

During MD Editing mode, when this button is pressed, the Editing mode is cancelled, and the deck returns to Normal mode.

34 PLAY (▶) button

Press this button to start playback when the MD deck is in stop or standby mode.

When MD recording is in standby mode, pressing this button starts MD recording.

When this button is pressed during dubbing standby mode, the CD deck begins playback and the MD deck begins recording, and dubbing begins.

35 READY (II) button

When this button is pressed during MD playback or while stopped, the MD deck enters standby mode.

When this button is pressed during MD recording, the MD deck enters recording standby mode.

36 RECORD (●) button

When this button is pressed and there is no MiniDisc in the mechanism, the input signal can be monitored.

If a recordable MiniDisc is inserted into the mechanism while it is stopped, when this button is pressed, the MD deck enters recording standby mode, and the input signal can be monitored.

When this button is pressed during recording, a track mark is entered at that point and a new track is started.

37 KEYBOARD connector

An IBM PC/AT compatible keyboard with PS/2 interface can be connected to this terminal to enable certain operations of the MD-CD1MKIII with the keyboard.

The key arrangement of a keyboard is divided into two types: US and JP. The setting of this unit needs to be configured. Check the specified keyboard type in the menu settings. (See "Keyboard type setting" on page 46.)

Display

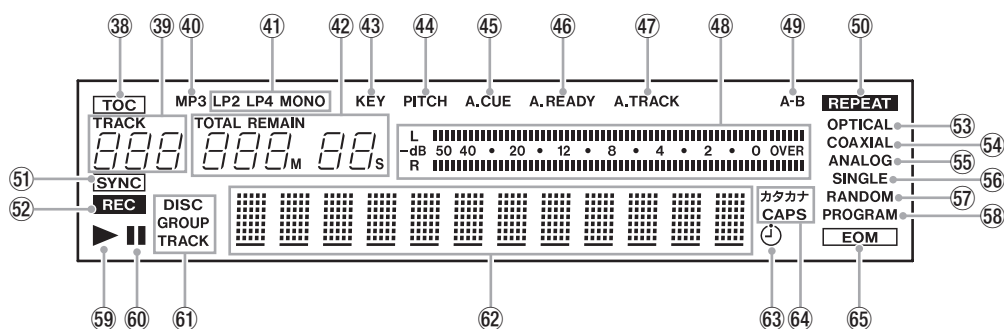

This display shows various types of operation information, including CD and MD disc information, deck operation modes, and menu status. Disc and deck information for either CD and MD are shown by pressing either the **CD** button or the **MD** button, and the deck selected becomes the display master. Also, the **CD MENU** button or the **MD MENU** button can be pressed to call up the CD Menu or the MD Menu.

38 TOC

When the most recent TOC (Table of Contents) data has not been recorded, this lights up red.

39 Track number display

During playback or selection, the track number is displayed.

40 MP3

This indicator is lit when a data CD is in the CD deck.

41 MD recording mode display (LP2, LP4, MONO)

This indicates the recording mode of the MD. If the disc was recorded in Normal mode, it does not light up.

During MD playback, the recording mode of the MD is displayed.

42 Counter display

Depending on the time display mode, **TOTAL** or **REMAIN** is lit. Counter display indication is in minutes (three digits) and seconds (two digits).

43 KEY

This lights when the CD deck's Key Change function is on.

44 PITCH

This lights when the CD deck's Pitch Control function is on.

45 A. CUE

This lights when the display master deck's Auto Cue function is on.

46 A. READY

This lights when the display master deck's Auto Ready function is on.

47 A. TRACK

This lights when the display master deck's Auto Track function is on.

It flashes during recording, in recording standby mode, or when the Auto Track function is set to **Time**.

48 Meter

This displays the playback level of either the CD or MD deck, as well as the recording level of the MD deck.

49 A-B

This lights when the display master deck's A-B Repeat function is on.

50 REPEAT

This lights when the display master deck's Repeat function is on.

51 SYNC

This lights during SYNC recording mode.

52 REC

This lights when the MD deck is recording, or in recording standby mode.

53 OPTICAL

This lights when the MD input source is set to digital (OPTICAL).

54 COAXIAL

This lights when the MD input source is set to digital (COAXIAL).

55 ANALOG

This lights when the MD input source is set to analog.

56 SINGLE

This lights when the display master deck is in single playback mode.

57 RANDOM

This lights when the display master deck is in random playback mode.

58 PROGRAM

This lights when the display master deck is in program playback mode.

59 ▶

This lights when the display master deck is in playback or recording mode. Also, when the Auto Cue function is on, it flashes during Auto Cue point search.

4 – Names and Functions of Parts

- 60 **II**
This lights when the display master deck is in recording standby or playback standby mode.
- 61 **DISC, GROUP, TRACK display**
DISC lights up when the display master deck has a disc loaded and is stopped.
GROUP lights up when the display master is the CD deck and the Directory playback mode is on, or when the display master is the MD deck and the group playback mode is on.
TRACK is indicated during playback or playback standby.
- 62 **Character display**
Disc information, track information, menu, message and operation status are displayed.
- 63 
This lights when the Timer Play function is on. It flashes if a disc is not loaded when the Timer Play function is on.
- 64 **CAPS, カタカナ**
These light during title input to indicate either CAPS or Japanese character mode. In lower case letter mode, there is no indication.
- 65 **EOM**
This lights when the remaining track/disc time is less than the EOM set value.

Rear Panel

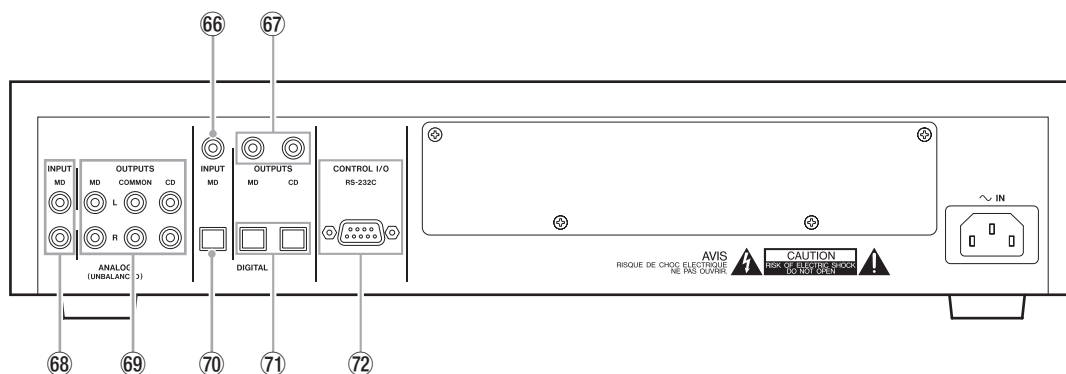

- 66 **DIGITAL INPUT MD (coaxial) Terminal**
This is the digital input terminal (coaxial) for the MD deck.
- 67 **DIGITAL OUTPUTS – MD – CD (coaxial) Terminals**
These are the digital output terminals (coaxial). The playback signals from the MD deck and the CD deck are output through their respective digital output terminals.
- 68 **ANALOG INPUT MD (UNBALANCED) Terminals**
The analog line input terminals for the MD deck are for RCA pin jacks. Rated input level is -10 dBV.
- 69 **ANALOG OUTPUTS – MD – COMMON – CD (UNBALANCED) Terminals**
The analog line output terminals are for RCA pin jacks. Rated output level is -10 dBV.
MD: Outputs the MD deck signal. During playback, the playback signal is output; during input monitoring, the source signal is output.
COMMON: Outputs CD and MD signals. During playback of both decks, the output signal depends on the **COMMON?** option setting on the **SYSTEM** menu.
- CD:** Outputs the CD deck signal.
- 70 **DIGITAL INPUT MD (optical) Terminal**
This is the digital (optical) input terminal for the MD deck.
- 71 **DIGITAL OUTPUTS – MD – CD (optical) Terminals**
These are the digital output terminals (optical). The playback signals from the MD deck and the CD deck are output through their respective digital output terminals.
- 72 **CONTROL I/O (RS-232C) Connector**
RS-232C compatible serial control from an external computer can be performed.

Remote Control Unit

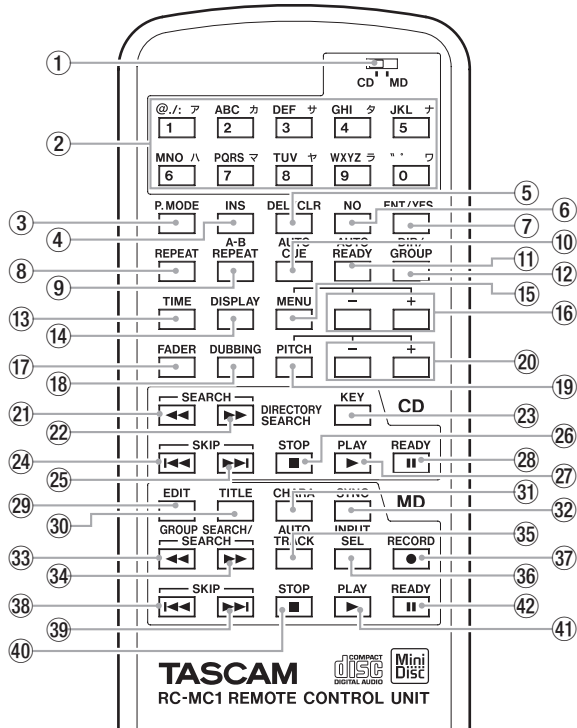

Shared operation buttons

CD/MD selector ① is used to select CD or MD deck operation, while buttons ② and beyond are shared operation buttons. ③ and subsequent buttons control the deck selected using CD/MD selector ① as the “remote control master”.

① CD/MD selector

Selects the remote control master. Refer to “Display master and remote master settings” on page 27.

② Number buttons (0 – 9)

These are used to select track numbers and for time search. During MD Title Input mode, they can be used to input letters, codes, numbers and Japanese characters. Characters that can be input are indicated above the buttons.

NOTE

- Track number selection and time search can only be performed for the display master deck. These functions cannot be operated for the deck selected as the remote control master.
- While these buttons can also be used for character input during title input operation, in this manual they are referred to as “Number buttons.”

③ P. MODE button

This selects the playback mode. During selection, the playback mode is indicated on the display in the following manner.

Continuous playback (in disc order): no indication
 Single playback: SINGLE lights up
 Program playback: PROGRAM lights up

Random playback: RANDOM lights up

For the modes apart from continuous playback, refer to “Single-track playback” on page 30, “Program playback” on page 30 and “Random playback” on page 31.

Even when the power is turned off, the playback mode setting is retained.

④ INS button

During MD Title Input mode, this button inserts a space at the cursor position.

⑤ DEL/CLR button

During track number input, the track number is cleared when this button is pressed.

During program input, the selected program number track is deleted.

During title input, the character at the cursor position is deleted.

⑥ NO button

This operates the same way as the NO button on the unit.

⑦ ENT/YES button

This operates the same way as the YES and ENTER buttons on the unit.

⑧ REPEAT button

This turns the Repeat Mode on and off. When it is on, REPEAT lights up in the display. Refer to “Repeat playback” on page 29. Even when the power is turned off, the Repeat Mode setting is retained.

⑨ A-B REPEAT key

This turns the A-B Repeat Mode on and off, and is used to set the section for repeat playback. Refer to “A to B repeat playback” on page 29.

⑩ AUTO CUE button

This turns the Auto Cue Mode on and off. When it is on, A. CUE lights up in the display. Refer to “Auto cue” on page 28. Even when the power is turned off, the Auto Cue Mode setting is retained.

⑪ AUTO READY button

This turns the Auto Ready Mode on and off. When it is on, A. READY lights up in the display. Refer to “Auto ready (of a specified track)” on page 28. Even when the power is turned off, the Auto Ready Mode setting is retained.

⑫ DIR/GROUP button

When this button is pressed during stop, it turns on or off the data CD directory playback mode (when the CD deck is the remote control master) or the MD group playback mode (when the MD deck is the remote control master). Refer to “MP3 and WAV file directory playback” on page 33, and “MD group playback” on page 34.

⑬ TIME button

This operates in the same way as the TIME button on the unit.

4 – Names and Functions of Parts

14 **DISPLAY button**

When pressed during stop mode, the current disc title is displayed.

When pressed during playback or playback standby mode, the current track title is displayed. Also, if the CD/MD Selector is set to the side which is not the current display master, pressing the DISPLAY button will change the current display master setting.

15 **MENU button**

This button is used to turn on and off the Menu of the current remote control master deck.

It operates in the same way as the **CD MENU** and **MD MENU** buttons on the unit.

16 **MENU +/- button**

During Menu Mode, this button is used to select menu options and make settings. It operates in the same way as the **MULTI JOG** dial on the unit. However, you cannot select a track.

17 **FADER button**

When pressed during CD playback standby, the sound will fade in when playback resumes. When pressed during CD playback, the sound will fade out.

When pressed during MD recording standby, the sound will fade in when recording begins. When pressed during MD recording, the recorded sound will fade out.

18 **DUBBING button**

This operates in the same way as the **DUBBING** button on the unit. Refer to "Dubbing from CD to MD" on page 35.

19 **PITCH button**

This operates in the same way as pressing the **PITCH** button/dial on the CD operation section of the unit, and is used to turn the pitch control on and off. Refer to "Pitch control" on page 30. Even when the power is turned off, the pitch control on/off setting is retained.

20 **PITCH +/- button**

This operates in the same way as when rotating the **PITCH** button/dial on the CD operation section of the unit. When pitch control is on, the pitch value can be set. Refer to "Pitch control" on page 30. Even when the power is turned off, the pitch setting is retained.

CD Operation Section

21 **SEARCH ◀◀ button**

During playback or playback standby, press this button continuously for review playback (search).

When a data CD is in the deck during stop mode, if this button is pressed, the directory can be chosen (backward direction).

22 **SEARCH ▶▶ button**

During playback or playback standby, press this button continuously for cue playback (search).

When a data CD is in the deck during stop mode, if this button is pressed, the directory can be chosen (forward direction).

23 **KEY button**

This turns the Key Change function on and off. When it is on, the musical key of CD playback can be changed. Key change settings can be performed from the CD menu. Refer to "Changing the key of playback" on page 32. Even when the power is turned off, the key change settings are retained.

24 **SKIP ◀◀ button**

During normal playback, use this button to skip through tracks in the reverse direction for selection. During stop mode, press this button to skip through tracks backwards, or press it continuously to skip at high speed. During playback, press this button to skip back to the start of the track in play.

25 **SKIP ▶▶ button**

During normal playback, use this button to skip through tracks in the forward direction for selection. During stop mode, press this button to skip through tracks forwards, or press it continuously to skip at high speed. During playback, press this button to skip to the start of the next track.

26 **STOP (■) button**

Operation is the same as with the **STOP** button on the CD operation section of the unit.

27 **PLAY (▶) button**

Operation is the same as with the **PLAY** button on the CD operation section of the unit.

28 **READY (II) button**

Operation is the same as with the **READY** button on the CD operation section of the unit.

MD Operation Section

②9 EDIT button

During normal operation, Menu mode and Title Input mode, press this button to enter MD Edit mode. Refer to “MiniDisc editing” on page 40.

When this button is pressed during MD Edit mode, the unit returns to normal operation mode.

③0 TITLE button

During normal operation, Menu mode and MD Edit mode, press this button to enter Title Input mode. Refer to “Title input” on page 44.

When this button is pressed during Title Input mode, the unit returns to normal operation mode.

③1 CHARA button

During Title Input mode, press this button to switch between types of input characters. Refer to “Title input” on page 44.

The type of character selected is indicated by the display.

Lower case letters/code: no indication

Capital letters/code: CAPS

Japanese: カタカナ

③2 SYNC button

This button is used to turn SYNC recording on or off. When on, recording is automatically started and stopped depending upon the input signal level. Refer to “Sync recording” on page 39.

When on, the SYNC indicator in the display lights up.

③3 GROUP SEARCH/SEARCH ◀◀ button

During playback or playback standby, press this button continuously for review playback (search).

When Group mode is on during stop mode, if this button is pressed, groups can be chosen (backward direction).

③4 GROUP SEARCH/SEARCH ▶▶ button

During playback or playback standby, press this button continuously for cue playback (search).

When Group mode is on during stop mode, if this button is pressed, groups can be chosen (forward direction).

③5 AUTO TRACK button

During MD recording, this is used to set the Auto Track function. OFF, -**dB or Time can be selected. Refer to “Update (Move up) a track number” on page 37.

Even when the power is turned off, the settings are retained.

③6 INPUT SEL button

Operation is the same as with the INPUT SELECT button on the unit, and is used to choose the MD input source. This button always functions, regardless of the remote control master setting. Refer to “Input source selection” on page 36.

③7 RECORD (●) button

Operation is the same as with the RECORD button on the MD operation section of the unit.

③8 SKIP ◀◀ button

During normal playback, use this button to skip through tracks in the reverse direction for selection. During stop mode, press this button to skip through tracks backwards, or press it continuously to skip at high speed. During playback, press this button to skip back to the start of the track in play.

During title input mode, press this button to move the cursor in the left direction.

③9 SKIP ▶▶ button

During normal playback, use this button to skip through tracks in the forward direction for selection. During stop mode, press this button to skip through tracks forwards, or press it continuously to skip at high speed. During playback, press this button to skip to the start of the next track.

During title input mode, press this button to move the cursor in the right direction.

④0 STOP (■) button

Operation is the same as with the STOP button on the MD operation section of the unit.

④1 PLAY (▶) button

Operation is the same as with the PLAY button on the MD operation section of the unit.

④2 READY (II) button

Operation is the same as with the READY button on the MD operation section of the unit.

5 – Display Master and Remote Control Master

The MD-CD1MKIII is equipped with a CD deck and an MD deck. Since the display and remote control buttons can be used by either deck, this function determines which deck is represented by their operation.

In this manual, the deck represented by the information in the display is referred to as the “display master,” while the deck being operated by the shared buttons on the remote control unit is referred to as the “remote control master.”

Selecting the remote control master

On the upper part of the remote control, there is a **CD/MD** selector used to select the remote control master. The shared buttons on the upper portion of the remote control unit operate for the deck selected as the remote control master.

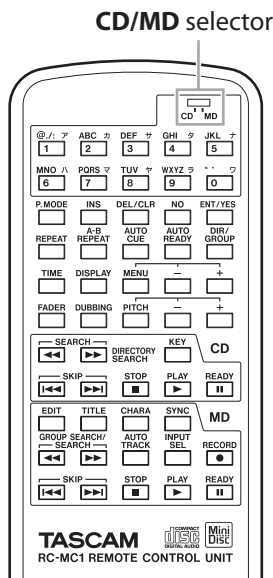

Selecting the display master

The display master can be selected using the **CD** or **MD** buttons. The **CD** or **MD** indicator lights up to show the selection.

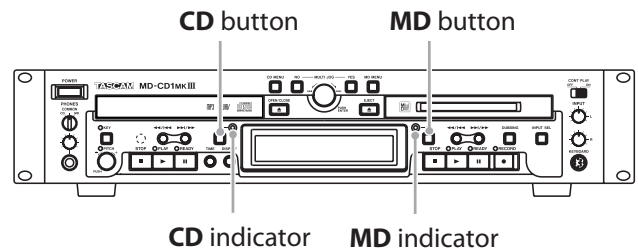

To switch the display master using the remote control, set the **CD/MD** selector to the desired position, then press the **DISPLAY** button.

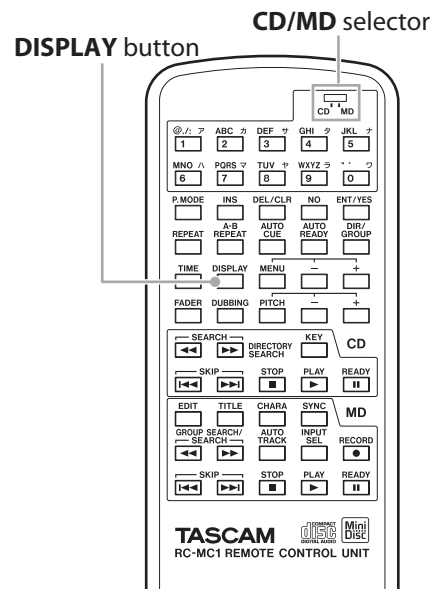

NOTE

When using the shared buttons on the remote control unit for operation, if the remote control master deck and the display master deck are not the same, the results of the operation will not be indicated on the display. To confirm operation results, the remote control master deck and the display master deck must be the same.

6 – Menu Operation

The various settings and editing operations possible with the MD-CD1MKIII are performed through menu options shown on the display. Among the many menu setting options, some may be made directly using the buttons on the remote control.

Menu configuration

There are menus for both CD and MD operation. Below each menu are sub-menus, and in each submenu there are menu options. The menus are configured as shown below.

CD Menu

| Menu option | Function | Manual reference | Page |
|--|--|---------------------------------------|------|
| CD PLAY sub-menu (options for CD playback) | | | |
| PLAY MODE | Playback mode settings | "Playback modes" | 26 |
| REPEAT | Repeat mode settings | "Repeat playback" | 29 |
| A_CUE LEVEL | Auto Cue level setting | "Auto cue" | 28 |
| A_CUE | Auto Cue on/off | "Auto cue" | 28 |
| A_READY | Auto Ready on/off | "Auto ready (of a specified track)" | 28 |
| PITCH STEP | Pitch control variable pitch setting | "Pitch control" | 30 |
| EOM TRK | Track EOM mode and operation time | "End of disc/track warning" | 32 |
| EOM DISC | Disc EOM mode and operation time | "End of disc/track warning" | 32 |
| TIMER PLAY | Timer play on/off | "Timer playback" | 29 |
| KEY LEVEL | Key control level setting | "Changing the key of playback" | 32 |
| DIR MODE | Data CD directory playback mode on/off | "MP3 and WAV file directory playback" | 33 |
| MP3 ACTION | Setting the error handling during MP3 file playback | "Setting MP3 ACTION" | 33 |
| CD VOL FUNC sub-menu (CD volume function options) | | | |
| PLAY VOLUME | Output level setting | "Output volume" | 33 |
| FADE IN | Fade-in operation time setting | "Fade-in and fade-out" | 32 |
| FADE OUT | Fade-out operation time setting | "Fade-in and fade-out" | 32 |
| FADE MODE | Setting operation mode after fade-out end | "Fade-in and fade-out" | 32 |
| SERIAL sub-menu (RS-232C data communication options) | | | |
| BAUD RATE | data transmission speed setting | "Data settings/service data" | 49 |
| LENGTH | data word length setting | "Data settings/service data" | 49 |
| PARITY | data parity bit setting | "Data settings/service data" | 49 |
| STOP BIT | data stop bit setting | "Data settings/service data" | 49 |
| SYSTEM sub-menu (options for the unit) | | | |
| KEYBOARD | setting for keyboard type | "Keyboard type setting" | 46 |
| COMMON | CD/MD priority for COMMON output | "Basic playback operation" | 26 |
| CD P_TIME | Confirming total CD playing time | "Data settings/service data" | 49 |
| MD P_TIME | Confirming total MD playing time | "Data settings/service data" | 49 |
| MD R_TIME | Confirming total MD recording time | "Data settings/service data" | 49 |
| IR REMOTE | Disabling/Enabling remote control (RC-MC1) operation | "Operation basics" | 25 |
| PANEL LOCK | Disabling/Enabling panel operation | "Locking the panel operations" | 48 |
| F_PRESET | Resetting all data to initial default settings | "Viewing service data" | 49 |
| CLEAR PROG | Deleting a program | Erase a CD or MD program | 31 |

6 – Menu Operation

MD Menu

| Menu option | Function | Manual reference | Page |
|---|---|---|------|
| MD PLAY sub-menu (options for MD playback) | | | |
| PLAY MODE | Playback mode settings | "Playback modes" | 26 |
| REPEAT | Repeat mode settings | "Repeat playback" | 29 |
| A_CUE LEVEL | Auto Cue level setting | "Auto cue" | 28 |
| A_CUE | Auto Cue on/off | "Auto cue" | 28 |
| A_READY | Auto Ready on/off | "Auto ready (of a specified track)" | 28 |
| EOM TRK | Track EOM mode and operation time | "End of disc/track warning" | 32 |
| EOM DISC | Disc EOM mode and operation time | "End of disc/track warning" | 32 |
| TIMER PLAY | Timer play on/off | "Timer playback" | 29 |
| GRP MODE | Group playback mode on/off | "MD group playback" | 34 |
| MD VOL FUNC sub-menu (MD volume function options) | | | |
| REC VOLUME | Input level setting | "Basic recording" | 36 |
| FADE IN | Fade-in operation time setting | "Fade-in and fade-out recording" | 38 |
| FADE OUT | Fade-out operation time setting | "Fade-in and fade-out recording" | 38 |
| FADE MODE | Setting operation mode after fade-out end | "Fade-in and fade-out recording" | 38 |
| REC sub-menu (options for MD recording status) | | | |
| REC MODE | Recording mode setting | "Basic recording" | 36 |
| REC SPEED | Dubbing speed setting | "Basic recording" | 36 |
| SYNC LEVEL | Operation level setting of Sync recording | "Sync recording" | 39 |
| SYNC | Sync recording mode on/off | "Sync recording" | 39 |
| A_TRK TIME | Operation time setting of Auto track | "Update (Move up) a track number" | 37 |
| A_TRK LEVEL | Auto track operation level setting | "Update (Move up) a track number" | 37 |
| A_TRK | Auto track mode setting | "Update (Move up) a track number" | 37 |
| PRE REC | Pre recording time setting | "Prerecording (Time Machine recording)" | 38 |
| EDIT sub-menu (options for MD editing functions) | | | |
| DIVIDE | Dividing tracks | "Divide tracks (DIVIDE)" | 41 |
| COMBINE | Combining tracks | "Combine tracks (COMBINE)" | 42 |
| MOVE | Moving tracks | "Move tracks (MOVE)" | 42 |
| GRP CREATE | Creating groups | "Creating a group" | 42 |
| GRP CANCEL | Eliminating a group | "Deleting a group" | 43 |
| ERASE DISC | Erasing disc content | "Erase disc (ERASE DISC)" | 40 |
| ERASE TRK | Erasing a track | "Erase track (ERASE TRK)" | 40 |
| ERASE MULTI | Erasing multiple tracks at once | "Erase multiple tracks at once (ERASE MULTI)" | 41 |
| UNDO | Undoing an editing operation | "MiniDisc editing" | 40 |
| TITLE sub-menu (options for MD title editing functions) | | | |
| TITLE INPUT | Input of track or disc title | "Title input" | 44 |
| TITLE GRP | Input of a group title | "Group title input" | 45 |
| CLEAR PROG | Deleting a program | Erase a CD or MD program | 31 |

Operation basics

1 Select CD Menu or MD Menu.

Front panel operation:

Press the **CD MENU** button or the **MD MENU** button to call up the desired menu.

Remote control operation:

Press the **MENU** button and either the **CD Menu** or the **MD Menu** is called up, depending upon the position of the **CD/MD selector**.

The sub-menu screen appears.

CD PLAY?

NOTE

- In Menu mode, the **CD** or **MD** indicators flashes to indicate which menu is called up.
- When a menu is chosen for a deck that is not the display master, the display master indicator will remain lit, while the indicator for the menu mode deck will begin flashing. If the menu for the display master deck is selected, its indicator will begin flashing.

2 Select the desired sub-menu.

Front panel operation:

Use the **MULTI JOG** dial to select, then press the **MULTI JOG** dial or the **YES** button.

Remote control operation:

Use the **MENU +/-** button to select, then press the **ENT/YES** button.

The screen for the selected menu option will be displayed.

PLAY MODE?

NOTE

To return to the sub-menu selection screen from a menu option selection screen, press the **NO** button on either the front panel or the remote control unit.

3 Select the desired menu option.

Front panel operation:

Use the **MULTI JOG** dial to select, then press the dial.

Remote control operation:

Use the **MENU +/-** button to select, then press the **ENT/YES** button.

The setting screen will be displayed.

Mode>Cont

NOTE

To return to the menu option selection screen, press the **NO** button on either the front panel or the remote control unit. However, if the **NO** button is pressed for an **EDIT** menu option, you will exit the Menu mode.

4 Settings

Front panel operation:

Use the **MULTI JOG** dial to select, then press the dial.

Remote control operation:

Use the **MENU +/-** button to select, then press the **ENT/YES** button.

NOTE

- Some menu options exist for confirmation purposes only, and setting cannot be performed.
- For MD Editing Menu operation, refer to “MiniDisc editing” on page 40.
- For Title Menu operation, refer to “Title input” on page 44.

5 How to exit Menu mode after setting (or confirmation), during menu option display.

Front panel operation:

Press the **CD MENU** or **MD MENU** button corresponding to the current Menu mode.

Remote control operation:

Press the **MENU** button.

The **CD** or **MD** indicator will stop flashing.

NOTE

The **IR REMOTE?** option on the **SYSTEM** sub-menu of the **CD** menu enables you to set the unit so that it will not respond to remote control button operations (excluding certain buttons). Set the option to **Enable** so that the unit will respond to all remote control button operations.

7 – CD and MD Playback

The MD-CD1MKIII can play both CDs and MDs. Basic playback and the operation of most playback functions are virtually identical for the CD and MD decks. This section will explain the shared playback functions first, followed by playback functions for CD only, data CD directory playback, and MD group playback.

Discs for playback

The CD and MD decks in the MD-CD1MKIII can play back the types of discs listed below.

CD deck

Ordinary audio CDs available commercially (recorded in CD-DA format)

CD-R and CD-RW discs recorded in CD-DA format, and properly finalized

MP3 files recorded in ISO9660 format on CD-R and CD-RW discs, and properly finalized.

MD deck

Audio MiniDiscs recorded in standard, LP2, LP4 and mono modes.

Playback modes

There are four different playback modes for both the CD deck and the MD deck. The mode selected is indicated on the display.

Normal playback (continuous) mode: no indication

Single playback mode: SINGLE is lit

Program playback mode: PROGRAM red light is lit

Random playback mode: RANDOM red light is lit

The playback mode can be selected using the **P. MODE** button on the remote control. Pressing the button changes the playback mode in the following order:

Normal playback → Single → Program → Random

- The playback mode appears on the display when changed.
- You can also select the playback mode using the **PLAY MODE?** option in the **PLAY** sub-menu of the CD and MD menus.

While the mode can be changed from any playback mode, the explanation in this manual will assume the user is starting from the normal playback (Continuous) mode.

Basic playback operation

■ CD:

- 1 **Push the POWER switch to turn on the unit.**

The display will indicate NO DISC.

- 2 **Press the OPEN/CLOSE button, and the CD tray opens.**

- 3 **Place the CD in the tray, label side up.**

- 4 **Press the OPEN/CLOSE button again, and the CD tray closes.**

After a disc is set, the total playing time and number of tracks will be displayed.

NOTE

At step 4 above, instead of the **OPEN/CLOSE** button, if the **PLAY** button is pressed, the CD tray will close and playback will begin, and if the **READY** button is pressed, the CD tray will close and the unit will enter playback standby mode.

- 5 **Press the PLAY button.**

The ► indication will light up, and playback begins from track 1. The number of the current track in play is indicated on the display.

- 6 **To pause playback, press the READY button. The II indication will light up, and the unit will enter playback standby mode. To resume playback, press the PLAY button.**

- 7 **To play a desired track, press either the I◀◀ or ▶▶I button on the front panel or on the remote control. You can also use the number buttons on the remote control. Refer to "Track selection" on page 27.**

- 8 **To stop playback, press the STOP button.**

- 9 **To remove the disc, press the OPEN/CLOSE button.**

■ MD:

- 1 **Push the POWER switch to turn on the unit.**

The display will indicate NO DISC.

- 2 **Insert the MiniDisc into the MD slot, in the direction of the arrow, and with the label side up.**

After a disc is inserted, the disc title (if there is one), and the total playing time and number of tracks will be displayed.

- 3 **Press the PLAY button.**

The ► indication will light up, and playback begins from track 1. The number of the current track in play is indicated on the display.

- 4 **To pause playback, press the READY button. The II indication will light up, and the unit will enter playback standby mode. To resume playback, press the PLAY button.**

- 5 **To play a desired track, press the I◀◀ or ▶▶I button on the front panel or on the remote control.**

You can also use the number buttons on the remote control. Refer to “Track selection” on page 27.

- 6 To stop playback, press the STOP button.
- 7 To remove the MD, press the EJECT button.

About the monitor

Using headphones

Plug the headphone cord into the **PHONES** jack located under the **POWER** switch. Use the source selection switch to choose the desired source, and adjust the volume with the volume control. If the source selection switch is set to **COMMON**, both CD and MD sources can be monitored. When both decks output a signal, the monitored source depends on the **COMMON?** option setting on the **SYSTEM** menu.

CAUTION

When using headphones, take care not to turn the volume too high. Listening at high volumes for extended periods of time may result in permanent hearing damage.

COMMON output

Signals are output from both the CD and MD decks through the rear panel **COMMON** terminal and the headphone terminal with the source switch set to “COMMON”.

However, if both decks are outputting signals, priority is given to signals from the deck (CD or MD) set in **COMMON?** in the **SYSTEM** submenu of the CD menu.

NOTE

Priority is given to the deck set in **COMMON?** for the **COMMON** output source.

Display master and remote master settings

For simple playback operation, the front panel buttons or the remote control buttons can be used. However, to ensure that the deck and disc information is properly shown on the display, the ‘display master’ setting must be selected for the deck in use. Also, when performing various playback operations by remote control, the ‘remote control master’ setting must be selected for the deck in use. Refer to “Display master and remote control master” on page 22.

To prevent operation errors, we recommend that the display master and the remote control master be set for the same deck.

Track selection

Using the skip function

Select desired tracks for playback with the skip buttons (I◀◀ / ▶▶I) on the front panel or on the remote control. After selecting the track, press the **PLAY** buttons to start playback, or the **READY** buttons to cue the track and enter playback standby mode.

To restart playback from the beginning of the track in play, press the I◀◀ button once. To skip to the previous track, press I◀◀ twice.

To skip to the next track, press ▶▶I once.

Selecting by track number

Using the number buttons on the remote control, the number of the desired track can be entered directly.

Even numbers with two or three digits can be entered easily. For example:

Track 9: press ‘9’ and 009 will be displayed.

Track 12: press ‘1’ and ‘2’ and 012 will be displayed.

Track 103: press ‘1’ and ‘0’ and ‘3’ and 103 will be displayed.

After input, press the **PLAY** button to start playback, or the **READY** button to cue the track and enter playback standby mode.

NOTE

A computer keyboard allows you to select a track number more easily for the 10 tracks from the beginning of the disc using the “direct track” function. (See “12 Using a computer keyboard – Direct track operation” on page 47)

Search

During playback or playback standby, this function enables the search of a desired portion within a track for playback.

- Front panel operation: press the I◀◀ / ▶▶I search button continuously. Be sure to hold the button down; if you quickly release it, the Skip function will operate.
- Remote control operation: continuously press the ◀◀ / ▶▶ search button.

NOTE

The Search function does not operate with data CDs.

7 – CD and MD Playback

Time Search function

By specifying time from the start of a certain track, you can start playback from a specified point of a specified track.

Basic operation

- 1 **During stop, playback or playback standby modes, use the number buttons on the remote control to input the three-digit track number (such as 002 for track 2), then the desired elapsed time (**min **sec) from the start of that track.**

Example: To specify 1 min 30 sec from the start of track 2, input “002 001 30.”

NOTE

- This function is not available in random playback mode, program playback mode, or group playback mode.
- For data CDs, time cannot be specified within a track. However, if you input the three-digit track number, playback will begin from the start of that track.
- During input, the counter in the display will flash.
- Regardless of the time display mode, the time from the start of the specified track is displayed.

When the final digit is entered, the desired position is automatically located. During stop or playback modes, playback will begin from the desired point. During playback standby mode, at the desired point the unit will enter playback standby mode.

NOTE

If a point which does not exist is selected, setting operation will be cancelled.

Operation variations

Even if the final second is not input, playback will begin from the selected point after pressing the **PLAY** button. Or, if you press the **READY** button, the unit will enter the playback standby mode at the selected point.

Track search

This is explained in the “Specifying by track number” part of “Track selection” on page 27.

After inputting the three-digit track number, press the **PLAY** button to begin playback of that track, or the **READY** button to cue the track and enter playback standby mode.

Specifying to the minute

After inputting the three-digit track number and the number of minutes after the start of the track, press the **PLAY** button to begin playback of that track, or the **READY** button to cue the track and enter playback standby mode.

Example: To specify 1 min 00 sec from the start of track 2, input “002 001.”

NOTE

Following the above example, if “0021” is input, the same position will be located.

Auto cue

When the auto cue function is turned on, when a track is selected, the point where sound begins (not where the track begins) on that track is located, and the unit enters playback standby mode. Then, when the **PLAY** button is pressed, playback begins at exactly that point.

Auto cue on/off and the sound start position detection level can be set separately for CD and MD.

NOTE

- Auto Cue functions only for MD tracks recorded in the ST mode. For MD tracks recorded in MONO, LP2 or LP4 modes, the Auto Cue function will only cue to the very beginning of the track.
- During the stop mode, to cue to the start of sound on track one, just press the **READY** button.

Turning the Auto Cue function on and off

Press the **AUTO CUE** button on the remote control to turn this function of display master on and off.

You can also use the **A_CUE?** option on the **PLAY** submenu of the MD menu or CD menu to turn the Auto Cue function on and off for each deck. (Default position: OFF)

When the Auto Cue function is on, **A_CUE** is lit on the display.

Even when the power is turned off, the Auto Cue setting is maintained.

Setting the sound start position detection level

Use the **A_CUE LEVEL?** option on the **PLAY** submenu of the MD menu or CD menu to set the sound start position detection level. Settings can be made independently for each deck. The level can be set between -72 dB and -24 dB in 6 dB increments.

NOTE

When the Auto Cue point is being searched, the **▶** arrow flashes in the display, and audio output is muted.

Auto Ready

When the Auto Ready function is on, after each track is played, playback standby mode is entered at the start of the next track. Even when the Skip function is used to skip tracks, playback standby mode is entered at the start of the selected track.

NOTE

When the Auto Cue function is also on, playback standby mode is entered at the start of the sound on the selected track, and not the beginning of that track.

Turning the Auto Ready function on and off

Press the **AUTO READY** button on the remote control to turn the function of display master on and off.

You can also use the **A_READY?** option on the **PLAY** sub-menu of the **MD** menu or **CD** menu to turn the Auto Ready function on and off for each deck. (Default position: OFF)

When the Auto Ready function is on, **A_READY** is lit on the display.

Even when the power is turned off, the Auto Ready setting is maintained.

Repeat playback

Press the **REPEAT** button on the remote control to turn on the Repeat mode. In this mode, all the tracks on the disc are played continuously. During playback, if the Repeat mode is turned on, playback continues as before, and when the last track finishes, playback resumes from the first track. If Repeat mode is turned on when the deck is stopped, press the **PLAY** button to begin operation.

You can also use the **REPEAT?** option in the **PLAY** sub-menu of the **MD** and **CD** menus to turn the Repeat mode on and off for each deck.

Combining the Repeat mode with the Program, Single-track playback and Random playback functions will enable Program Repeat, Single-track Repeat and Random Repeat operations, respectively.

A to B repeat playback

If a specific portion between two points on the disc is specified, that portion can be played back repeatedly.

- 1 **During playback, press the A-B REPEAT button on the remote control at the beginning of the desired portion on the disc.**

A-B flashes on the display.

- 2 **At the end of the desired portion on the disc, press the A-B REPEAT button on the remote control again.**

REPEAT and **A-B** are lit up on the display, and the desired A-B section will be played repeatedly.

To cancel A-B Repeat mode and resume normal playback

Press the A-B REPEAT button once more.

When the STOP button is pressed, the specified A-B section is cancelled.

NOTE

- A-B repeat playback does not function for two different tracks of a CD.
- A-B repeat playback does not function for data CDs.

Continuous CD and MD playback

With this function, when one deck finishes, the other deck begins play.

- 1 **Turn on the CONT PLAY switch on the front panel.**
- 2 **Play a CD or MD.**

When the disc finishes playback, the disc in the other deck begins playing automatically.

When that disc finishes, the first disc is played again, and the playback cycle continues.

NOTE

- During Continuous Play, the deck currently in playback automatically becomes the display master.
- When the Repeat Mode is turned on, Repeat playback is performed instead of continuous playback. That is, Repeat Mode has priority over the Continuous Play function.

To cancel Continuous Play operation, press the STOP button.

Timer Playback

By using an external timer, you can set the MD-CD1MKIII to play the loaded disc automatically when the unit is turned on by the timer.

- 1 **First, plug the power cord of the MD-CD1MKIII into the power outlet of the timer.**
- 2 **Load a CD or an MD into the unit.**
- 3 **Use the TIMER PLAY? option on the PLAY sub-menu of the MD or CD menu to turn the timer function on for the desired deck.**

When Timer Play has been turned on, the timer icon lights up in the display.

- 4 **Set the timer to the desired time. Consult the timer's operation manual for details.**

At the set time, the power to the MD-CD1MKIII will be turned on, and playback will automatically begin.

NOTE

Only one deck can be selected for timer playback. This deck will become the display master during Timer Play operation.

7 – CD and MD Playback

Pitch control (CD only)

When playing back an audio CD, the pitch (or speed) of the playback can be varied. Pitch can be varied –50% to +16% for CD.

NOTE

Pitch control does not function for data CDs.

Front panel operation

- 1 During stop, playback or playback standby mode, press the PITCH control to turn the Pitch Control function on.
- 2 Rotate the PITCH control knob to set the pitch.

NOTE

Use the PITCH STEP? option in the PLAY sub-menu of the CD menu to adjust the pitch control steps from 0.1% to 1.0% in 0.1% increments. (Default: 0.1%)

Remote control operation

- 1 During stop, playback or playback standby mode, press the PITCH button to turn the Pitch Control function on.
- 2 Use the PITCH –/+ button to set the pitch. Pitch is adjusted in 0.1% increments.

NOTE

- Pitch control only functions during normal playback. During recording, pitch control does not function.
- When turning the pitch control on and off during playback, sound output is cut for a short instant.

Single-track playback

This function enables playback of just a single track.

During stop mode, press the P. MODE button on the remote control, and SINGLE lights up in the display.

Stops playback after playback of a track has finished.

NOTE

- If the Repeat function is also on, the selected track will be played repeatedly.
- You can also use the PLAY MODE? option in the PLAY sub-menu of the MD and CD menus to set the Single track playback mode.
- Even when the power is turned off, the Single-track playback mode settings are retained.

Program playback

This function enables playback of selected tracks in any desired order. Up to 99 tracks can be selected from a CD, or up to 25 tracks from an MD, for Program playback.

Programs of up to 100 discs including CD and MD can be retained.

- 1 During stop mode, press the P. MODE button on the remote control until PROGRAM is indicated on the display.

The program number and total program playing time will be shown on the character display. The highest program number among the currently registered programs appears on the program number display immediately after the mode is changed.

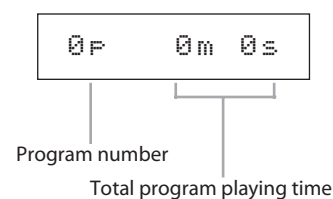

NOTE

- You can also use the PLAY MODE? option in the PLAY sub-menu of the MD and CD menus to set the Program Playback mode.
 - The total program playing time does not appear for data CDs.
 - Before setting up a program, press the STOP (■) button to enter stopped status.
- 2 Use the number buttons on the remote control to select each desired track for program playback, then press the ENT/YES button. The track number will be entered into the program.

NOTE

To set the program by front panel operation, use the MULTI JOG dial to select the track number, then press the dial to add the track to the program.

- 3 Repeat the above step 2 until the desired program is completed.

As the program is being created, the program number and total program playing time is revised on the display.

To confirm program contents, press the skip buttons during playback or playback standby.

NOTE

If the total program playing time exceeds 999 min 59 sec, "– – – m – – s" is displayed.

- 4 When program setting is completed, press the PLAY button to begin playback of the tracks in the programmed order.

Deleting a programmed track

- 1 **During STOP mode, use the skip button to select the track for deletion.**

The track number will be shown in the display.

- 2 **Press the DEL/CLR button.**

NOTE

Right after **STOP**, if the **DEL/CLR** button is pressed, the last track programmed will be deleted.

Adding a track to the program

- 1 **During STOP mode, using the skip buttons, skip to the programmed track before the position you wish to add a track.**

The track number should be shown on the display.

Example:

To add a new 3rd track (between 2nd and 3rd), display the 3rd track ("3p") of the program.

- 2 **Use the number buttons to input the track number of the track to be added.**

- 3 **Press the ENT/YES button on the remote control.**

NOTE

- Right after **STOP**, if the number of the track to be added is input, and the **ENT/YES** button on the remote control is pressed, the track will be added to the end of the program.
- To add a track to the program by front panel operation, use the **MULTI JOG** dial to select the track number, then press the dial.

Erase a CD or MD program

Insert the CD or MD for which you want to erase a program into the deck.

- 1 **Set the playback mode to Program.**
- 2 **Select "CLEAR PROG?" from the CD or MD menu.**

Sure? appears.

If the playback mode is not Program, Can't Sel! appears and you cannot select the option.

- 3 **Press the MULTI JOG dial (or YES key) on the unit or the ENT/YES key on the remote control.**

The program is erased. When the erasing is complete, Complete appears.

NOTE

The program is also erased if all tracks in the program are erased using the **DEL/CLR** button.

Program limitations

- With an MD, if the Group playback mode is on, programs that include more than one group cannot be created.
- With data CDs, if the Directory playback mode is on, programs that include more than one directory cannot be created.
- The same track may be repeated in a program.
- When 99 CD tracks (or 25 MD tracks) are entered into a program, if you attempt to add a track, PGM Full! will be displayed, and no more tracks can be added.

Saving program data

- Programs of up to 100 discs including CD and MD can be retained.
- For data CD, a single program uses double the usual capacity, so the maximum number retainable will be lower.
- If a created program exceeds the capacity, other programs will be automatically erased starting from the oldest.
- Programs on the currently inserted disc can be erased using the menu.
- CDs are distinguished by the total number of tracks (or files) and total recording time (total capacity in the case of data CD).
- MDs are distinguished by the total number of tracks and recorded time.
- Discs with the same total number of tracks and the same total recording time (total capacity in the case of data CD) are regarded as identical.

Random playback

In this mode, the deck will play back all the tracks on the disc in completely random order, regardless of track number.

- 1 **During stop mode, press the P. MODE button on the remote control until RANDOM is indicated on the display.**

NOTE

You can also use the PLAY MODE? option in the PLAY sub-menu of the MD and CD menus to set the Random Playback mode.

- 2 **Press the PLAY button.**

Random playback starts. Playback stops when all the tracks have been played once.

NOTE

Even when the power is turned off, the deck will remain in RANDOM mode.

7 – CD and MD Playback

Time display switching

During MD or audio CD playback (or playback standby), when the **TIME** button on either the front panel or the remote control is pressed, the time display will switch through several modes in the following order.

Elapsed track time: no display light indication

Remaining track time: **REMAIN** is lit in the display

Elapsed disc time: **TOTAL** is lit in the display

Remaining disc time: **TOTAL** and **REMAIN** are lit in the display

NOTE

- During MD playback, the remaining disc time indication, as with CD, shows the playback time remaining until the end of the disc. Please note that this may differ from the remaining time indicated when recording the MD.
- When stopped, the total recording time is shown, regardless of the status of the **TOTAL** and **REMAIN** indicators.
- When playing a data CD, elapsed track time is always displayed, and the **TIME** button does not operate.
- For details on time display during recording and recording standby on an MD deck, please refer to “Checking remaining MD time” on page 39.
- Even when the power is turned off, the time display mode setting is retained.

End of disc/track warning

When nearing the end of a track or disc, a warning indication is shown on the display.

The number of seconds before the track/disc end that the warning is displayed can be set beforehand, so that when playback reaches that point, the **EOM** warning will begin flashing on the display.

To set the warning display time, use the **EOM TRK?** or **EOM DISC** options on the **PLAY** submenu of the MD and CD menus. Each can be set between 1 and 99 seconds in 1-second increments, or the warning display can be turned off.

NOTE

The **EOM** warning function does not work with data CDs.

Playback functions for CD only

The following playback functions are for CD only, and are not available for MD playback.

Changing the key of playback

The key of the music can be changed during CD playback. Please note that this feature does not operate with data CDs.

- 1 **Use the **KEY LEVEL?** option on the **PLAY** submenu of the **CD** menu to change the key. The playback key can be raised or lowered 1/2 octave in half-tone increments.**

Selection values: 0 (no change), \flat 1 to \flat 6, #1 to #6

- 2 **Press the **KEY** button on the front panel to turn the **Key Change** function on.**

The **KEY** indication lights up in the display.

NOTE

- Each time the **KEY** button is pressed, the function is switched on or off. When the function is on, instead of an **On** indication, the key selected (in operation 1 above) is indicated on the display. For example: **KEY \flat 2**
In this condition, when a CD is played back, the key of the music is changed while the speed of the music remains the same.
- Even when the power is turned off, the key change setting is retained.
- When the Key Change function is on, even if the Pitch Control function is used to change the playback speed, the key of playback will remain fixed at the preset key. (Even if the key level is 0 (zero), the Key Change function can be turned on.)
- When using the key control function, playback sound may occasionally sound like vibrating. This is a result of a special process applied to CD playback sound and is normal.

Fade-in and fade-out

When this function is on, when CD playback begins the song fades in, and when playback finished the song fades out.

- 1 **To set the fade operation, use the menu options shown below. They can be found under the **VOL FUNC** sub-menu in the **CD** menu.**

FADE IN

The length of the fade in to the normal level can be set between 1 and 30 seconds in 1-second increments. (Default setting: 3 seconds).

FADE OUT

The length of the fade out into complete silence can be set between 1 and 30 seconds in 1-second increments.

(Default setting: 3 seconds).

FADE MODE

The deck can be set to continue playback (“Play”) or enter playback standby mode (“Ready”) after fadeout is completed.

2 In stop mode or playback standby mode, press the FADER button on the remote control.

Playback begins and the sound fades in.

After the preset fade-in time, the sound is at normal level.

3 During playback, press the FADER button on the remote control when you wish to fade-out the sound.

Fade-out begins, and after the preset fadeout time, there is silence. After it becomes silent, depending upon the Fade mode setting, playback continues or the deck enters playback standby mode.

Output volume

The volume of the CD playback output signal can be adjusted. This adjustment functions for both for analog output (including headphone output) and digital output.

1 Setting is made using the PLAY VOLUME? option on the VOL FUNC sub-menu of the CD menu.

The level can be set between -54 dB and $+18$ dB, or “- - -” (- infinity) can be selected.

NOTE

Since volume adjustment is performed in the digital domain, if the output level is excessive in the plus direction, digital distortion will be generated.

MP3 and WAV file directory playback

MP3 and WAV files recorded onto a CD are handled the same way as files are handled in an ordinary PC, with some MP3 and WAV files held within a directory. In addition, several directories can be combined into one directory. This results in multiple layers of directories and files.

When the Directory playback mode is on, only those files within a selected directory are available for playback.

When the mode is turned off, all MP3 and WAV files stored on the disc are played regardless of the directory structure.

Please note that Program playback and Repeat playback only function within directories.

NOTE

- Each MP3 or WAV file is handled as a track.
- Directories which do not contain MP3 or WAV files directly under them cannot be selected for playback. For example, in the diagram below, under directory

A are directory B and directory C. If there are MP3 or WAV files in both directory B and C, directory A cannot be selected for playback, but directory B and C can be selected for playback.

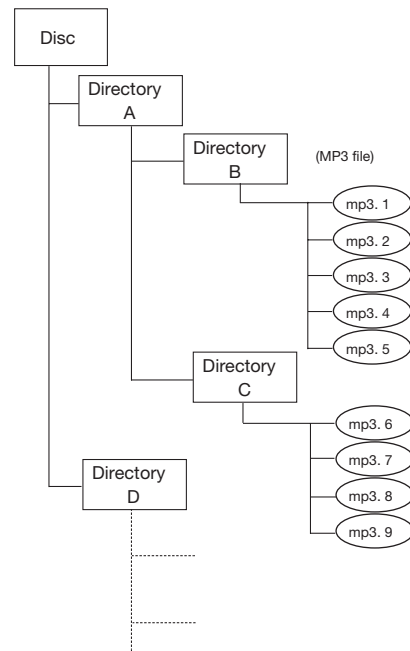

Example of directory structure

Directory playback setting

1 Set the remote control master to CD, and press the DIR/GROUP button.

DIR ON or DIR OFF will be shown in the display. When the DIR/GROUP button is pressed, the current setting is changed. For example, if the directory playback mode is off, when the button is pressed, the mode is turned on and DIR ON is displayed.

You can also use the DIR MODE? option in the PLAY sub-menu of the CD menu to turn this mode on or off.

2 During Stop mode, the CD SEARCH button on the remote control can be used to select a directory.

Press the CD SEARCH button, and the selected directory title will be shown on the display.

Setting MP3 ACTION

You can choose whether the unit continues playback or stop when MP3 or WAV playback fails.

1 Select MP3 ACTION? option on the PLAY submenu of the CD menu.

2 Select “Skip” or “Stop.”

Skip

When MP3 or WAV playback fails, the unit skips the current track and advances to the next track. Playback will stop if the current track is the last track (i.e., if the

7 – CD and MD Playback

repeat function is off and the current track is the last track on the disc or in the program).

Stop

When MP3 or WAV playback fails, the unit stops playback.

NOTE

If MP3 or WAV playback fails during dubbing mode, the unit stops playback regardless of the MP3 ACTION setting.

MD group playback

The MD-CD1MKIII allows MD tracks to be divided into groups.

When the Group playback mode is on, only those tracks in the selected group are available for playback. This is like playing a disc which only contains the tracks in a selected group. Accordingly, Program playback and Repeat playback only function within the group.

Group playback setting

1 Set the remote control master to MD, and press the DIR/GROUP button.

GRP ON or GRP OFF will be shown in the display.

When the **DIR/GROUP** button is pressed, the current setting is changed. For example, if the Group playback mode is off, when the button is pressed, the mode is turned on and GRP ON is displayed.

You can also use the GRP MODE? option in the PLAY sub-menu of the MD menu to turn this mode on or off.

2 During Stop mode, the MD SEARCH button on the remote control can be used to select a group.

Press the MD SEARCH button, and the number of the selected group will be shown on the display, followed by the group title.

NOTE

- When Group mode is on, regardless of the group, tracks which are not in the group cannot be played.
- When Group mode is turned on, recording is not possible.

Creating and deleting groups

Using the **EDIT** sub-menu of the MD menu, groups can be created or deleted. Refer to “Creating a group” and “Deleting a group” in the “MiniDisc editing” section starting on page 43.

Titling groups

You can title the groups using the **TITLE** sub-menu of the MD menu. Refer to “Group title input” on page 45.

8 – Dubbing from CD to MD

The MD-CD1MKIII makes it easy to dub from CD to MD. Selected tracks or the entire disc can be dubbed.

Basic dubbing operation

First, load the CD to be used as the dubbing source into the CD deck, then insert a recordable MiniDisc into the MD deck.

NOTE

Copy-protected CDs cannot be dubbed.

To dub the entire CD

While the CD deck is stopped, press the **DUBBING** button on either the front panel or the remote control.

To dub a selected track on the CD

During playback of the desired track, or when that track is cued and the deck is in playback standby mode, press the **DUBBING** button on either the front panel or the remote control.

The track is selected for dubbing.

Start dubbing

Dubbing can be started when preparation is complete and `Dubbing Wait` stops blinking.

Dubbing is started by pressing the **PLAY** button on the CD or MD control panel.

Fade-in recording is performed if the **FADER** button on the remote control is pressed instead of the **PLAY** button. (The speed changes to **NORMAL** if it has been set to **HIGH**.)

NOTE

If the level is set to anything other than 0dB in `REC VOLUME?,Vol> xx.xdB` blinks instead of `Dubbing Wait!` (xx.x: Setting value)

In this case, check the level as necessary.

Stop dubbing

Pressing the **STOP** button stops dubbing.

Dubbing ends in a fade-out if the **FADER** button on the remote control is pressed instead of the **STOP** button. (If dubbing started with a fade-in or if the speed is set to **NORMAL**)

If the end of a disc (when the entire disc is dubbed) or track (when a track is dubbed) is reached, the normal stop operation is performed even if dubbing started with a fade-in.

NOTE

- Dubbing is performed at the specified speed (see below).
- For the fade-in/fade-out time setting, see “Fade-in and fade-out recording” on page 38.

Recording mode setting

Using the `REC MODE?` option on the `REC` submenu of the MD menu, select the recording mode from the following choices.

| | | |
|------|-------------------------------------|-------------------------------------|
| ST: | standard stereo recording mode | default, with no display indication |
| MONO | monaural recording mode | MONO lights up in the display |
| LP2 | half-speed stereo recording mode | LP2 lights up in the display |
| LP4 | quarter-speed stereo recording mode | LP4 lights up in the display |

NOTE

- In MONO mode, the same signals are output from the left and right channels of the headphone terminal and rear panel audio output terminal.
- In MONO mode, the recording time is twice that in ST mode.
- The recording time in LP2 mode is twice that in ST mode.
- The recording time in LP4 mode is four times that in ST mode.
- The remaining MD recording time indicated depends upon the recording mode setting.
- Recordings made in different recording modes can be combined on the same disc.
- Since a special data compression technology is used for LP4 mode (quarter-time recording for four times the recording time in stereo), there is the very slight possibility of spikes of noise being generated. If sound quality is an important consideration, we do not recommend the use of the LP4 mode.

Dubbing speed setting

Use the `REC SPEED?` option on the `REC` submenu of the MD menu to select either **NORMAL** or **HIGH** speed dubbing.

NORMAL: dubbing is performed during regular playback.

HIGH (default setting): dubbing speed depends on the source disc and start mode, as indicated below.

| source disc | Start mode | dubbing speed |
|-------------|------------|---------------|
| Audio CD | Normal | 4X speed |
| Audio CD | Fade in | Actual speed |
| Data CD | --- | Actual speed |

TIP

- To listen while dubbing, select **NORMAL**. For faster dubbing, select **HIGH**.
- When Rec Speed is set to **NORMAL**, MD dubbing is possible even if the Key Change or Pitch Control functions have been used for CD playback.

9 – MD recording from an external source

The MD-CD1MKIII can not only dub from CD to MD, it also allows MD recording from other sound sources.

Basic recording

Set the recording mode and select the input source.

While monitoring the input signal, adjust the recording level. After all settings are complete, you are ready to make a recording.

Before following the procedures below, make sure the MD-CD1MKIII power is on, a recordable MiniDisc is in the deck, and the deck is in stop mode.

Recording mode setting

- 1 Use the **REC MODE?** option on the **REC** sub-menu of the **MD** menu to set the recording mode.

For more details, refer to the previous section “Dubbing from CD to MD” on page 35.

Input source selection

- 2 Use the **INPUT SEL** button on the front panel or the remote control to select the input source.

The source changes in the following order each time the button is pressed:

ANALOG → OPTICAL → COAXIAL

ANALOG

The analog signal from the **ANALOG INPUT** terminals is the recording source.

OPTICAL

The digital signal from the **DIGITAL INPUT MD (OPTICAL)** is the recording source.

COAXIAL

The digital signal from the **DIGITAL INPUT MD (COAXIAL)** is the recording source.

Even if the power is turned off, the selected input source is retained.

Input monitoring

- 3 Press the **RECORD** button on either the front panel or the remote control.

The MD deck will enter recording standby mode, the **READY** and **RECORD** indicators will light up, and **REC** and **II** will light up on the display.

NOTE

- The deck cannot enter recording standby mode in the following cases.
 - The tab on the MD cartridge is set to prevent recording, and **U_Protected** is displayed.
 - The disc is full, and **Disc Full!** is displayed.
 - The maximum number of tracks has been recorded, and **Track Full!** is displayed.
- When the digital input (OPTICAL or COAXIAL) is selected, if there is no proper digital signal input, “**D-IN**

UNLOCK!” will be displayed, and recording cannot be performed.

- If the level is set to anything other than 0dB in **REC VOLUME?**, **Vol1 > xx.xdB** blinks for three seconds. (xx.x: Setting value)
 - In this case, check the level as necessary.
- If a partially recorded disc is inserted, the end of the recorded portion will be detected.

The deck will enter recording standby mode, and the MD input signal can be monitored through headphones or a connected audio system.

NOTE

- If monitoring through a connected system, connect the **MD OUTPUTS** terminals to the system. Connection through the **COMMON OUTPUTS** terminal is also possible, but in this case, the appropriate setting must be made using the **COMMON?** option on the **SYSTEM** sub-menu of the **CD** menu.
 - Refer to “Connecting analog audio equipment” on page 13.
 - For details on headphone monitoring, refer to “Basic playback operation” on page 26.
- Even if no MD is inserted in the deck, it is still possible to monitor the input signal by pressing the **RECORD** button. In this case, **Monitor** will be shown in the display.
- To cancel input monitoring, press the **STOP** button.

Recording level adjustment

Adjust the recording level while monitoring the input and viewing the meters.

- 4 Use the **REC VOLUME?** option on the **VOL FUNC** sub-menu of the **MD** menu to adjust the level.
 - If **ANALOG** is selected as the input source, you may also use the front panel **INPUT** controls (L and R) to set the level independently for each channel.

NOTE

If the level is adjusted in **REC VOLUME?**, the volume is adjusted in the digital realm, but the volume of the monitor sounds output through headphones or of signals output through the **ANALOG OUTPUTS** terminal or **DIGITAL OUTPUTS** terminal does not change.

Be aware that digital distortion may occur if the maximum level is exceeded.

(If this happens, **OVER** on the level meter bar lights up.)

Recording start

- 5 In the recording standby mode, press the **PLAY** button, and recording will start.

To stop recording, press the **STOP** button.

After pressing the **STOP** button, **UTOC Writing!** will be shown on the display as the **User Table Of Contents** is written on the disc.

To pause recording, press the **READY** button.

9 – MD recording from an external source

To eject the disc from the deck, press the **EJECT** button during stop mode.

NOTE

When **UTOC Writing!** is flashing on the display, data on the recorded contents is being written onto the disc. During this process, if the power cord is unplugged from the power source, or the unit is moved or disturbed, this essential data cannot be correctly recorded on the disc.

Recording cautions

When “W_Protected!” is displayed

The inserted MD cannot be recorded, or a playback only MD was inserted.

Close the write protect tab to enable recording.

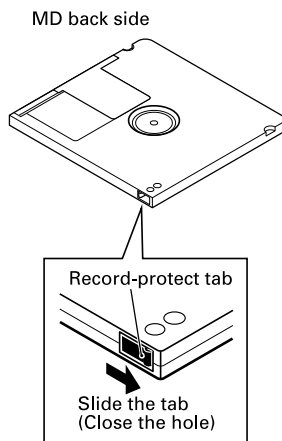

To prevent accidental erasure of the recording

After the source has been recorded onto an MD, slide the protect tab to open the hole.

NOTE

This unit conforms to SCMS. If connected digitally, the following restrictions apply:

| MD recording | | |
|-----------------------|------------------|-------------------|
| Original | First generation | Second generation |
| Copy-protected | Not permitted | Not permitted |
| Only first generation | OK | Not permitted |
| Copy possible | OK | OK |

Update (Move up) a track number

If tracks are numbered, it is convenient when editing or cuing the tracks. During recording, track numbers are entered automatically, and may also be entered manually either during or after recording.

NOTE

If a CD or MD is digitally recorded, the track numbers are automatically updated according to the track number

updating of the source, and the Auto Track function in **-**dB (Level in A_TRK?)** does not work.

For digital recording from any sources other than CD and MD, the Auto Track function in **-**dB (Level in A_TRK?)** works.

Auto track function

This function automatically enters track numbers during recording.

Set this function using the **AUTO TRACK** button on the remote control to select **OFF**, **-**dB**, **DD** or **TIME**.

You can also set the auto track function using the **A_TRK?** option in the **REC** sub-menu of the **MD** menu. (To set **-**dB**, select **Level** from the **A_TRK?** option.)

-**dB

If the signal falls below the Auto Track operation level for more than 2.5 seconds, a track number is automatically entered. To set this operation level, use the **A_TRK LEVEL?** option on the **REC** sub-menu of the **MD** menu. The level can be set between **-72 dB** to **-30 dB** in 6 dB increments.

TIME (Time Track Increment)

When the specified time (Auto Track operation time) has expired, track numbers will be updated automatically. Set this operation time using the **A_TRK TIME?** option on the **REC** sub-menu of the **MD** menu. The setting range is from one minute to 10 minutes (in one minute increments).

NOTE

- Even when the power is turned off, the Auto Track, Auto Track Level and Auto Track Time settings are retained.
- If you change the Auto Track operation time during recording, the change will be applied beginning with the next track.
- When the auto track mode is **Time** and the pre-recording function is activated, the first track will become longer by the specified pre-recording time than the time set in **A_TRK TIME?**

Update a track number manually

Pressing the **RECORD** button during recording updates the track numbers.

NOTE

When a track is divided manually, any new tracks must be longer than 4 seconds.

Update a track number after recording

Track numbers can be updated during editing operation. Refer to “Divide tracks (DIVIDE)” on page 41.

Or you can reduce the number of tracks by combining tracks using editing functions. Refer to “Combine tracks (COMBINE)” on page 42.

9 – MD recording from an external source

Fade-in and fade-out recording

At the beginning and end of MD recording, fade-in and fade-out effects can be performed.

Before following the procedure below, make sure that basic recording preparations have been completed, a recordable disc is inserted, and the deck is in stop mode.

- 1 **Set operation using the following menu options on the VOL FUNC sub-menu of the MD menu.**

FADE IN

The length of the fade in to the normal level can be set between 1 and 30 seconds in 1-second increments. (Default setting: 3 seconds).

FADE OUT

The length of the fade out into complete silence can be set between 1 and 30 seconds in 1-second increments. (Default setting: 3 seconds).

FADE MODE

The deck can be set to continue recording ("Rec") or enter recording standby mode ("Ready") after fadeout is completed.

- 2 **In recording standby mode, press the FADER button on the remote control.**

Recording begins and the sound fades in.

After the preset fade-in time, the sound is at normal level.

- 3 **During recording, press the FADER button on the remote control when you wish to fade-out the sound.**

Fade-out begins, and after the preset fade-out time, there is silence. After it becomes silent, depending upon the Fade mode setting, recording continues or the deck enters recording standby mode.

NOTE

- Fade-in or fade-out only may be selected.
- The Prerecording function cannot be performed together with fade-in recording. For details, refer to the following section.
- The unit adjusts the level for fade-in/fade-out in the digital realm, but the volume of the monitor sounds output through headphones or of signals output through the **ANALOG OUTPUTS** terminal or **DIGITAL OUTPUTS** terminal does not change.

Prerecording (Time Machine recording)

This function makes it possible to start recording up to 6 seconds before the time the recording operation is actually started. It operates by holding the input signal in a buffer memory that can be set to contain up to 6 seconds of data representing a normal stereo input signal.

Before following the procedure below, make sure that basic recording preparations have been completed, a recordable disc is inserted, and the deck is in stop mode.

- 1 **Set the time value for the amount of data to be stored in the buffer using the PRE REC? option on the REC sub-menu of the MD menu.**

Setting values range from 1 to 6 seconds in 1-second increments, as well as OFF. The default setting is OFF.

OFF: The Prerecording function does not operate.

1 sec to 6 sec settings: The buffer will hold the corresponding seconds of signal.

- 2 **Press the RECORD button to enter recording standby mode.**

- 3 **Press the PLAY button to start recording.**

The signal will be recorded from the number of seconds set before the **PLAY** button is pressed.

- 4 **Press the STOP button to stop recording.**

NOTE

When performing fade-in recording (explained in a previous section), the prerecording function is not possible.

Overwrite recording

The overwrite recording function allows you to automatically delete and overwrite a previously recorded portion after the specified position.

Before following the procedure below, make sure that basic recording preparations have been completed, a recordable disc is inserted, and the deck is in stop mode.

- 1 **Locate the point at which you wish to begin overwrite recording, press the READY button, and the deck will go into playback standby mode.**

To start overwrite recording from the beginning of a certain track, use the SKIP button or the number buttons to select the track, then press the READY button.

To start overwrite recording from the middle of a certain track, use the SKIP buttons or the number buttons to select the desired track, then press the PLAY button to begin playback (you can also use the Search function). At the desired point, press the READY button.

9 – MD recording from an external source

- 2 Press the **RECORD** button, **Over Write** will be shown on the display, and the deck will enter recording standby mode.

Adjust the recording level if necessary.

- 3 Press the **PLAY** button and overwrite recording begins.

NOTE

When **SINGLE**, **RANDOM** or **PROGRAM** lights up in the display, overwrite recording cannot be performed. In the case of step 2 above, **Can't Rec** will be displayed.

Sync recording

The Sync recording function automatically begins recording when the signal from external equipment is present in the source input. Plus, if silence in the source signal continues for more than four seconds, the deck is automatically put into the recording standby mode.

Before following the procedure below, make sure that basic recording preparations have been completed, a recordable disc is inserted, and the deck is in stop mode.

- 1 Press the **SYNC** button on the remote control to select on or off.
You can also switch the **SYNC** recording function on or off using the **SYNC?** option on the **REC** sub-menu of the **MD** menu.
- 2 Set the signal detection threshold level using the **SYNC LEVEL?** option on the **REC** sub-menu of the **MD** menu. The level can be set from **-72 dB** to **-30 dB** in **6 dB** increments.
The default setting is **-54 dB**.
- 3 Press the **RECORD** button to enter recording standby mode.

NOTE

In this status, recording will begin as soon as a source signal is input.

- 4 **Input the source signal.**

When a source signal is detected, recording begins automatically.

If the signal is under the threshold level for over four seconds, the deck automatically enters recording standby mode.

NOTE

During **SYNC** recording standby, recording cannot be started manually by pressing the **PLAY** button.

- 5 **To manually stop recording, press the STOP button.**

NOTE

- During **SYNC** recording, even if the **READY** button is pressed, the recording standby mode cannot be entered. (The button cannot be used to pause recording.)

- The **INPUT SEL** button does not function during **SYNC** recording.
- After **SYNC** recording finishes and the deck enters recording standby mode, if the power is turned off the recording data will be deleted. Make sure to press the **STOP** button so that the **U-TOC** is written onto the disc before turning the power off.

Checking remaining MD time

During MD recording or recording standby mode, press the **TIME** button on either the front panel or the remote control, and the elapsed track recorded time and remaining recording time will be shown in succession on the display.

| Display indication | Time display |
|---|-----------------------------|
| No indication | Elapsed track recorded time |
| REMAIN only, or TOTAL and REMAIN will light up | Disc remaining time |

Even if the power is turned off, the time settings will be retained.

10 – MiniDisc editing

Tracks recorded can be deleted, moved, divided or combined by MiniDisc editing operation.

In addition, tracks can be grouped.

Editing operations

All MD editing functions are operated from the EDIT sub-menu on the MD menu.

After selecting a menu option on the EDIT sub-menu, subsequent operation will vary. Specific operations for each menu option are explained individually in the following section.

NOTE

Editing functions cannot be performed on discs set to prevent accidental erasure (write protected), and `W_Protected!` will be displayed when accessing the EDIT sub-menu of the MD menu.

Tracks and points for editing

For most editing menu options, if the deck is not in play or in playback standby mode at the track or point to be edited, the option itself cannot be selected, and `Can't Edit!` will be displayed. These are options for editing functions to be performed on tracks or points, including `DIVIDE`, `COMBINE` and `MOVE`. The `ERASE TRK` option is called up before the track has been selected.

Canceling edits

To cancel editing operations up to the point where the setting screen or confirmation screen (`Sure?`) appears, press the **NO** button, the MD **STOP** button, or the **MD MENU** button (**MENU** button on the remote control).

NOTE

After editing operations have been completed, with the MD still inserted and **TOC** lit up on the display, if the power is turned off, the revised U-TOC will not be written on the disc, and the editing operation will not be retained on the disc.

UNDO an edit operation (UNDO function)

It is possible to cancel the most recently performed editing operation.

- 1 **Stop the MD deck.**
- 2 **Select the `UNDO?` option from the EDIT sub-menu.**
`Undo> ***` is displayed, with `***` representing the last performed editing option.
- 3 **Press the MULTI JOG dial (or the YES button) on the front panel, or the ENT/YES button on the remote control.**

`Sure?` is displayed.

- 4 **Press the ENTER button (or the YES button) on the front panel, or the ENT/YES button on the remote control.**

The last editing operation performed will be undone.

Erase disc (ERASE DISC)

All the tracks on the disc can be erased in one operation.

- 1 **Select the `ERASE DISC?` option on the EDIT sub-menu of the MD menu.**

`Sure?` is displayed.

- 2 **Press the MULTI JOG dial (or the YES button) on the front panel, or the ENT/YES button on the remote control.**

After all the tracks on the disc are erased, `Complete` is shown on the display.

Erase track (ERASE TRK)

Unwanted tracks can be erased one at a time

Example: To erase B in track number 2

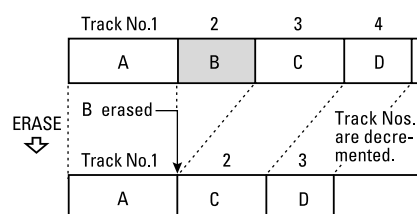

Selecting a track to be erased by playback

- 1 **The deck should be in play or in playback standby on the track to be erased.**
- 2 **Select the `ERASE TRK?` option on the EDIT sub-menu of the MD menu.**
`Sure?` is displayed.
- 3 **Press the MULTI JOG dial (or the YES button) on the front panel, or the ENT/YES button on the remote control.**

After the track is erased, `Complete` is shown on the display.

Selecting a track to be erased on the menu

- 1 **In the stop mode, select the `ERASE TRK?` option on the EDIT sub-menu of the MD menu.**
`Track>***` will be displayed, with `***` representing the last track number.
- 2 **Select the track to be erased using the MULTI JOG dial on the front panel, or the MENU +/- button on the remote control.**

- 3 Press the **MULTI JOG** dial (or the **YES** button) on the front panel, or the **ENT/YES** button on the remote control.

Sure? is displayed.

- 4 Press the **ENTER** button (or the **YES** button) on the front panel, or the **ENT/YES** button on the remote control.

After the track is erased, **Complete** is shown on the display.

NOTE

When a track is erased, the tracks are renumbered from the next track.

Erase multiple tracks at once (ERASE MULTI)

You can erase multiple tracks at once by specifying a range.

Example: To erase C in track number 3 and D in 4

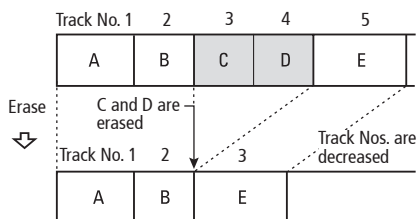

- 1 While MD playback is stopped, select **ERASE MULTI?** from the **EDIT** submenu of the MD menu.
ST Trk> 001 appears.
While this is displayed, select the starting track.
- 2 Use the **MULTI JOG** dial to select the starting track.
- 3 Press the **MULTI JOG** dial (or **YES** key) on the unit or the **ENT/YES** key on the remote control.
ED Trk> ### appears.
While this is displayed, select the ending track.
- 4 Use the **MULTI JOG** dial to select the ending track.
- 5 Press the **MULTI JOG** dial (or **YES** key) on the unit or the **ENT/YES** key on the remote control.
Sure? appears.
- 6 Press the **MULTI JOG** dial (or **YES** key) on the unit or the **ENT/YES** key on the remote control.
The tracks are erased. When the erasing is complete, **Complete** appears.

NOTE

- If tracks are erased, the numbers of subsequent tracks are decreased by the number of erased tracks.
- This function is not available if the disc contains a group. (Can't Edit! appears.)

Divide tracks (DIVIDE)

Tracks can be divided into two or more tracks.

Example: To divide C and D contained in track number 3 into two tracks

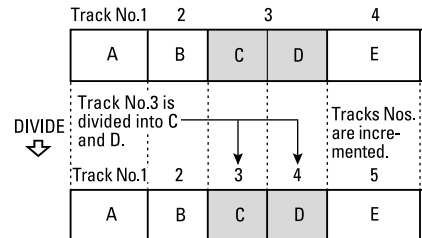

- 1 Select the **DIVIDE?** option on the **EDIT** sub-menu of the MD menu.
- 2 Play back the track to be divided, and at the desired divide point, press the **MULTI JOG** dial (or the **YES** button) on the front panel, or the **ENT/YES** button on the remote control.

Point> 0 appears, and several seconds before and after the division point (where the above button operation was performed) are played back repeatedly. You can check the division as short muted spaces are placed before and after the division point.

NOTE

- As an alternate procedure to steps 1 and 2 above, play the track to be divided, and at the desired point, put the deck into playback standby mode. Then select the **DIVIDE?** option on the **EDIT** sub-menu of the MD menu, and **Point> 0** will be displayed. Starting at the divide point (specified in the above operation) a few seconds are played back repeatedly to enable confirmation.
- 3 If necessary, use the **MULTI JOG** dial on the front panel, or the **MENU +/-** button on the remote control to adjust the divide point.
 - 4 After the divide point has been set, press the **MULTI JOG** dial (or the **YES** button) on the front panel, or the **ENT/YES** button on the remote control.
Sure? is displayed.
 - 5 Press the **MULTI JOG** dial (or the **YES** button) on the front panel, or the **ENT/YES** button on the remote control.
After the track is divided, **Complete** is shown on the display.

NOTE

- If a track is divided, the track numbers of subsequent tracks are incremented.
- If a title has been added to the track, the title of the second track will be the same as that of the first one.

10 – MiniDisc editing

Combine tracks (COMBINE)

Two successive tracks can be combined into one track by deleting the track mark of the second track.

Example: To combine B and C

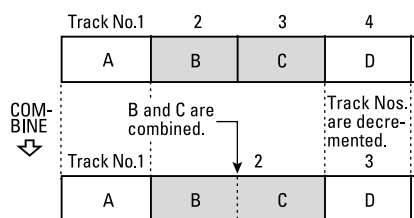

NOTE

Successive tracks recorded with different recording modes cannot be combined into a single track.

- 1 Put the deck in play or in playback standby on the second of the two tracks to be combined.

For example, if tracks 2 and 3 are to be combined, play track 3 or put it in playback standby mode.

- 2 Select the **COMBINE?** option on the EDIT sub-menu of the MD menu.

Track OK? is displayed, and a 3-second segment from the end of the first track and a 3-second segment from the start of the second track are successively played back repeatedly to enable confirmation.

- 3 Press the **MULTI JOG** dial (or the **YES** button) on the front panel, or the **ENT/YES** button on the remote control.

After the tracks are combined, **Complete** is shown on the display.

NOTE

- If tracks are combined, the track numbers of subsequent tracks are decremented.
- If both tracks have titles, the combined track will take the title of the first of the two tracks.

Move tracks (MOVE)

Tracks can be moved to different positions in the playing order.

Example: To move D from track number 4 to track number 2

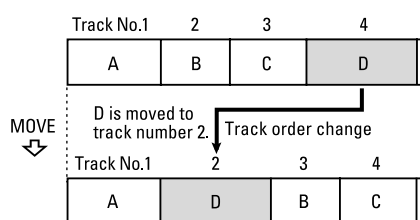

- 1 Put the deck in play or in playback standby on the track to be moved.

NOTE

If the above step is not performed first, and the following operations are performed while the deck is in stop mode, the last track will automatically be selected as the track to be moved.

- 2 Select the **MOVE?** option on the EDIT sub-menu of the MD menu.

Move ***>###" is displayed, with *** representing the number of the track to be moved, and ### representing the track number where it will be moved.

- 3 Use the **MULTI JOG** dial on the front panel, or the **MENU +/-** button on the remote control to select the track number where it will be moved.

- 4 Press the **MULTI JOG** dial (or the **YES** button) on the front panel, or the **ENT/YES** button on the remote control.

Sure? is displayed.

- 5 Press the **MULTI JOG** dial (or the **YES** button) on the front panel, or the **ENT/YES** button on the remote control.

After the track is moved, **Complete** is shown on the display.

NOTE

If a track is moved, the track numbers are updated.

Creating a group

The MD-CD1MKIII enables tracks to be divided into groups on a single MD disc for playback by group. Refer to "MD group playback" on page 34.

A group is created by specifying track numbers of the "starting" track and the "ending" track.

- 1 In stop mode, select the **GRP CREATE?** option from the EDIT sub-menu of the MD menu.

ST Trk> 001 is displayed. This shows the starting track selection.

- 2 Use the **MULTI JOG** dial to select the starting track.

- 3 Press the **MULTI JOG** dial (or the **YES** button) on the front panel, or the **ENT/YES** button on the remote control.

ED Trk>*** is displayed. This shows the ending track selection.

- 4 Use the **MULTI JOG** dial to select the starting track.

- 5 Press the **MULTI JOG** dial (or the **YES** button) on the front panel, or the **ENT/YES** button on the remote control.

Sure? is displayed.

- 6 Press the **MULTI JOG** dial (or the **YES** button) on the front panel, or the **ENT/YES** button on the remote control.

After the specified group is created, **Complete** is shown on the display.

Disc title when creating a group

When creating a group, a disc title containing the group information or the group title is automatically created.

For example, if the original title of the disc is `Favorites` and tracks 1 to 4 are combined into a group titled `Jazz` and tracks 5 to 8 are combined into a group titled `Latin`, the new title of the disc will be:

`0; Favorites//1-4; Jazz//5-8; Latin//`

Deleting a group

Groups can also be deleted.

- 1 In stop mode, select the `GRP CANCEL?` option from the `EDIT` sub-menu of the `MD` menu.**

`GRP No> 01` is displayed.

- 2 Use the `MULTI JOG` dial to select the number of the group to be deleted.**

If all the current groups are to be deleted, select `ALL`.

- 3 Press the `MULTI JOG` dial (or the `YES` button) on the front panel, or the `ENT/YES` button on the remote control.**

`Sure?` is displayed.

- 4 Press the `MULTI JOG` dial (or the `YES` button) on the front panel, or the `ENT/YES` button on the remote control.**

After the specified group is deleted, `Complete` is shown on the display.

11 – Title input

Titles can be given to the MD disc, and the tracks and groups on it, using the TITLE sub-menu on the MD menu.

NOTE

As with the Editing menu, after the name is set, if the power is turned off while the MD is still inserted (TOC lights up), the revised U-TOC will not be recorded on the disc, and the title will not be input.

Disc title input (TITLE)

- 1 In the stop mode, select the TITLE INPUT? option on the TITLE sub-menu on the MD menu.**
Title> Disc will be displayed.
- 2 While Title> Disc is displayed, press the MULTI JOG dial (or the YES button) on the front panel, or the ENT/YES button on the remote control.**
The current disc title is shown on the character display, title edit mode is entered, and the cursor flashes.

NOTE

- If there is no current title, nothing will be shown on the display, and only the cursor will flash.
 - If a group is set, the default title automatically created by the MD-CD1MKIII will be displayed. Refer to “Creating a group” on page 42.
- 3 Add a title following the guidelines below, and press the MD MENU button or the MENU button on the remote control to confirm.**

NOTE

For discs with groups, set the Group playback mode to on before inputting a title. If a title is added with the Group playback mode off, the group settings may become inoperative.

Title input operation

In Title Input mode, the cursor flashes in the character display. Since it is more efficient to use the remote control to input titles, the following explanation will center on its use.

NOTE

It is even more efficient to connect a keyboard for title input. Refer to “Title input by keyboard” on page 46.

Follow the guidelines below to input titles on the screen.

Select the type of character for input

Press the **CHARA** button on the remote control to select from three different types of characters.

Lower case letters/code: no indication

Capital letters/code: CAPS

Japanese: カタカナ

For front panel operation, use the **DISPLAY** button.

Input procedure

Use the number buttons to input characters at the cursor position.

Press the number buttons the necessary number of times to get the desired character to appear on the display.

To insert a space in entered text, press the **INS** key.

Example: In lower case letters/code mode, the letter changes in the following order each time the 2 key is pressed:

a → b → c → 2 → a

Front panel operation: Press the **YES** key to insert a space. Use the **MULTI JOG** dial to select a character.

To move the cursor position

Use the skip buttons.

However, if a different number button is pushed, the cursor automatically moves to the right.

For front panel operation, use the skip buttons.

To delete characters

Set the cursor on the character to be deleted, then press the **DEL/CLR** button on the remote control.

For front panel operation, use the **NO** button.

To change a character

Delete a character following the above procedure then input a new character, or move the cursor to a character then use the **MENU-/+** key on the remote control or the **MULTI JOG** dial on the unit to select the character.

NOTE

As with the Editing menu, after the name is set, if the power is turned off while the MD is still inserted (TOC lights up), the revised U-TOC will not be recorded on the disc, and the title will not be input. The U-TOC is recorded when the disc is ejected.

Track title input

Method 1

With this method, the tracks for title input are selected first.

- 1 Put the deck in playback or playback standby mode on the track you wish to add a title. During recording, you may also input a title for the current track being recorded.**
- 2 Select the TITLE INPUT? option on the TITLE sub-menu of the MD menu, and press the MULTI JOG dial (or the YES button) on the front panel, or the ENT/YES button on the remote control.**

The title of the track in play will be shown on the character display, Title Edit mode is entered, and the cursor flashes.

NOTE

If there is no track title, only the cursor will flash and nothing will be displayed.

- 3 **Following the title input guidelines above, input the title, and press the MD MENU button on the front panel or the MENU button on the remote control to confirm.**

■ Method 2

With this method, the Title Input mode is selected first.

- 1 **During stop mode, select the TITLE INPUT? option on the TITLE sub-menu on the MD menu.**

Title> Disc is displayed.

- 2 **Select the track for title input using the MULTI JOG dial on the front panel, or the MENU +/- button on the remote control, then press the MULTI JOG dial (or the YES button) on the front panel, or the ENT/YES button on the remote control.**

For example, select Title> 003 to choose track 3.

When a selection is made, the current track title is shown on the character display, Title Edit mode is entered, and the cursor flashes.

NOTE

If there is no track title, only the cursor will flash and nothing will be displayed.

- 3 **Add a title following the procedure of “Title input operation” on the previous page, then press the MD MENU key on the unit (or the MENU key on the remote control) to confirm the title.**

Group title input

- 1 **During stop mode, select the TITLE GRP? option on the TITLE sub-menu on the MD menu.**

Title Grp> ** is displayed, with ** representing the group number.

- 2 **Press the MULTI JOG dial on the front panel or the ENT/YES button on the remote control.**

The current group title is shown on the character display, Title Edit mode is entered, and the cursor flashes. The group number flashes on the track number display.

- 3 **Following the guidelines for title input methods above, input the title, and press the MD MENU button on the front panel or the MENU button on the remote control to confirm.**

12 – Using a Computer Keyboard

Connecting a PS/2 interface keyboard for IBM PC/AT compatible computers to the front panel of the unit allows you to use the keyboard to operate the unit. Various controls are available, and in particular title input will be more efficient.

Keyboard type setting

The MD-CD1MKIII must be set for the type of keyboard being connected.

Set the type using the KEYBOARD? option on the SYSTEM sub-menu of the CD menu.

Select US for an English-language keyboard, or JP for a Japanese-language keyboard.

Title input by keyboard

Titles can be input just like typing on a PC.

To enter the Title Edit menu

Press SHIFT + F7 to enter the Group Title Edit Menu.

Title Grp>## is shown on the display.

Press SHIFT + F8 to enter the Disc/Track Title Edit Menu.

Title> ## is shown on the display.

To select the type of characters for input

Press CAPS to select or cancel upper case letters

Press the (katakana) key to select or cancel Japanese characters (Japanese-language keyboards only)

If both of the above are cancelled, lower case letters are input

To input characters

Character input is performed directly with the letter and number keys.

To move the cursor

Use the cursor arrow keys ← and →.

To delete characters

Delete key: deletes the character in the cursor position

Back space key: deletes the character before the cursor position

To change a character

Delete a character following the above procedure then input a new character.

Other keyboard operations

The keyboard can be used not only for title input, but also to control the deck transports, perform editing functions and other operations. The list below shows the keys that perform various operations.

| Keyboard key | Operation |
|--------------|--------------------------------------|
| F1 | MD I◀◀ |
| F2 | MD ▶▶I |
| F3 | MD button |
| F4 | MD STOP |
| F5 | MD PLAY |
| F6 | MD READY |
| F7 | AUTO CUE for MD |
| F8 | MD RECORD |
| F9 | AUTO READY for MD |
| F10 | REPEAT for MD |
| F11 | PLAY MODE for MD |
| SHIFT + F1 | MD EDITERASE TRK |
| SHIFT + F2 | MD EDITERASE DISC |
| SHIFT + F3 | (inoperative) |
| SHIFT + F4 | MD EDIT MOVE |
| SHIFT + F5 | MD EDIT DIVIDE |
| SHIFT + F6 | MD EDIT COMBINE |
| SHIFT + F7 | TITLE EDIT TITLE GRP |
| SHIFT + F8 | TITLE EDIT TITLE INPUT |
| SHIFT + F9 | UNDO |
| SHIFT + F10 | MD EDIT GRP CANCEL |
| SHIFT + F11 | MD EDIT GRP CREATE |
| SHIFT + F12 | DUBBING |
| CTRL + F1 | CD I◀◀ |
| CTRL + F2 | CD ▶▶I |
| CTRL + F3 | CD button |
| CTRL + F4 | CD STOP |
| CTRL + F5 | CD PLAY |
| CTRL + F6 | CD READY |
| CTRL + F7 | AUTO CUE for CD |
| CTRL + F8 | KEY button |
| CTRL + F9 | AUTO READY for CD |
| CTRL + F10 | REPEAT for CD |
| CTRL + F11 | PLAY MODE for CD |
| CTRL + F12 | same as pushing the CD PITCH control |
| CAPS | Select or cancel upper case letters |

| Keyboard key | Operation |
|--------------|---|
| カタカナ | (katakana) to select Japanese characters (Japanese-language keyboards only) |
| ←/→ | to move the cursor |
| Delete | Same as the DEL/CLR button |
| Back space | deletes the character before the cursor |
| Insert | Same as the INS button |
| ESC | Cancel edit or title edit and finish Menu mode |
| Enter | ENTER (pressing MULT JOG dial)/YES button |

Direct track operation

You can select a track number directly for the 10 tracks from the beginning of the disc using CTRL + No. keys or ALT + No. keys.

CTRL + No. keys: Select tracks 1 – 10 of a CD.

ALT + No. keys: Select tracks 1 – 10 of an MD.

Use No. keys 1 – 9 to select tracks 1 – 9, and 0 to select track 10.

NOTE

- In program playback mode, select program numbers 1 – 10.
- In random playback mode, the direct track function is not available.

13 – Locking the panel operations

You can lock the entire panel or individual decks in order to prevent misoperation. The entire panel can be locked after a deck has been locked. (If both locks are enabled, warning messages that appear refer to the lock of the entire panel.)

NOTE

Even if the lock of the entire panel is released, the lock of an individual deck is not released.

Locking the entire panel

Press and hold the **TIME** and **DISPLAY** keys simultaneously to lock/unlock the entire panel.

When the keys are locked, LOCKED appears on the display.

When the keys are unlocked, UNLOCKED appears on the display.

If a button is pressed while the keys are locked, **Key Locked** appears indicating that key operations are disabled.

The key lock setting is retained even when the power is turned off.

Locking individual decks

Select **CD deck only**, **MD deck only**, or **EJECT** button only under **PANEL LOCK?** in the **SYSTEM** submenu of the **CD** menu.

When none is selected

The lock is released, and all key operations are enabled.

When CD is selected

Key operations for the **CD** deck are disabled.

Keys disabled: **KEY**, **PITCH**, **◀◀/I◀◀**, **▶▶/▶▶**, **STOP**, **PLAY**, **READY**, **OPEN/CLOSE**

In addition, the **MULTI JOG** dial cannot be used to operate **CD**.

If a button on the **CD** deck is pressed, **CD Locked** appears indicating that key operations are disabled.

When “MD” is selected

Key operations for the **MD** deck are disabled.

Keys disabled: **◀◀/I◀◀**, **▶▶/▶▶**, **DUBBING**, **INPUT SEL**, **STOP**, **PLAY**, **READY**, **RECORD**, **EJECT**, **MD MENU**

If a button on the **MD** deck is pressed, **MD Locked** appears indicating that key operations are disabled.

In addition, the **MULTI JOG** dial cannot be used to operate **MD**.

When “EJECT” is selected

The **OPEN/CLOSE** key on the **CD** deck and the **EJECT** key on the **MD** deck are disabled.

If the **OPEN/CLOSE** key on the **CD** deck or the **EJECT** key on the **MD** deck is pressed, **Eject Locked** appears indicating that key operations are disabled.

NOTE

Even if the **OPEN/CLOSE** and **EJECT** keys are disabled, a disc is automatically loaded when the **CD** tray is pushed in or an **MD** is inserted.

Data communication settings

By connecting a PC through its RS-232C terminal to the MD-CD1MKIII through its **CONTROL I/O (RS-232C)** terminal, the two units can be linked for data exchange. Use the following options on the SERIAL sub-menu of the CD menu to perform their respective settings.

BAUD RATE

Sets the communication speed of the keyboard.

4800/9600/19200/38400 bps can be selected.

Default: 9,600

LENGTH

Communication word length can be set to either 7 or 8 bits.

Default: 8 bits

PARITY

Communication parity can be set to NON, EVEN or ODD.

Default: NON

STOP BIT

The data stop bit can be set to either 1 or 2.

Default: 1

Viewing service data

You can view service data via the following items in the SYSTEM submenu of the CD menu.

CD P_TIME

The total CD playback time is shown.

MD P_TIME

The total MD playback time is shown.

MD R_TIME

The total MD recording time is shown.

Initializing all data

You can reset all data to initial default settings.

- 1 Make sure that no disc is loaded in the MD or CD player. Select the F_PRESET? option on the SYSTEM sub-menu of the CD menu.**

The display indicates Sure?.

- 2 Press the MULTI JOG dial (or YES button) on the unit or the ENT/YES button on the remote control.**

All data will be initialized to the default settings.

CAUTION

- Do not turn off the power to the unit until the Complete indicator on the display disappears.
- If the settings are initialized, all the programs retained for each disc will be erased.

15 – System Limitations

CD section

About MP3 and WAV files

- The MD-CD1MKIII can play back MP3 and WAV files recorded in formats which conform to ISO9660 level 1, level 2, or Joliet. Discs recorded in multiple sessions may also be played back.
- For data CDs to be played by the MD-CD1MKIII, the following limitations have been placed on the number of MP3/WAV files and directories.

Maximum number of directories: 255

Maximum number of MP3/WAV files: 999

Maximum number of characters of title of MP3/WAV files and directories: 255

- MP3 and WAV files are played in the following order:

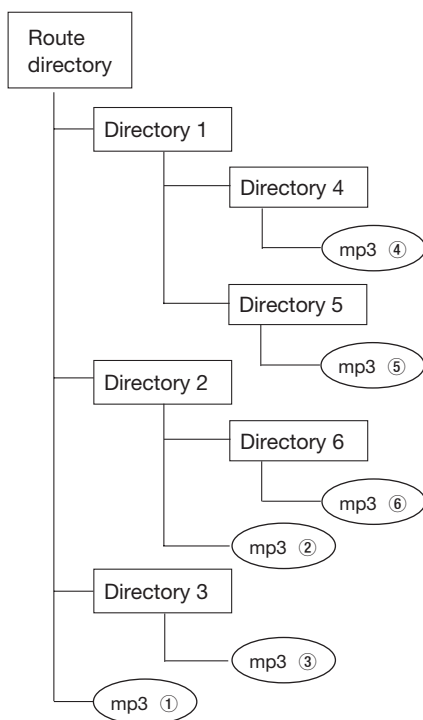

In this manner, playback is performed from the top level directories.

- About MP3 track data
During playback, titles are displayed in the following order of priority:
ID3v2 > ID3v1 > file title
During stop mode, the file title is displayed.

About CD-R/RW

CD-R/RW discs that have not been finalized cannot be played back. Make sure the disc has been properly finalized before loading into the player.

What is finalization?

Even if audio data is recorded onto a CD-R/RW disc, if the TOC (table of contents corresponding to the recorded data) is not written on the disc after recording, the disc cannot be played back on conventional CD players. "Finalization" is the process of writing the TOC on the disc.

Copy control CD discs

A number of record companies have released titles on 'copy control' CD discs as a means of protecting artist copyrights. Some of these discs do not comply with standard CD format specifications, and may not be able to be played on this unit.

MD section

Even when the maximum recording time is not reached, "Track Full!" is displayed.

Regardless of the time, when the maximum number of tracks has been reached, **Track Full!** is displayed. In the MiniDisc format, the number of tracks is limited to 255. To make an additional recording on discs with 255 tracks, unwanted tracks must be deleted, or tracks must be combined to reduce their number. If this is not possible, the additional recording must be made on a separate disc.

Even if the number of tracks or the recording time has not been exceeded, the **Track Full!** message is displayed.

If emphasis information, etc. is turned on/off during tracking, **Track Full!** may appear as the information is treated as track divisions and it has been calculated that the number of tracks including these divisions has exceeded 255.

Although tracks have been deleted, the remaining time on the MD disc does not increase.

When the remaining time on an MD disc is displayed, sections less than 12 seconds are ignored. So even if short tracks are eliminated, the remaining time indicated does not increase.

When elapsed recording time and remaining time are added up, it doesn't match the possible recording time of the MD disc.

Normally, the shortest possible recording unit is 1 cluster (about 2 seconds). Even if the recording is less than this, 2 seconds of space is taken up on the disc, so the actual possible recording time may be less than expected. Furthermore, if a scratch occurs on the disc itself, the area where it exists is automatically voided for use, so the

recording time possible in that section is subtracted from total recording time.

Tracks cannot be combined.

Tracks created through editing operation may not be able to be combined with other tracks.

If the recording mode (ST, MONO, LP2 or LP4) of two tracks differs, they cannot be combined.

If three or more tracks are to be combined, tracks less than a certain length (depending upon recording mode) cannot be used. The approximate minimum times are 9 seconds for ST mode, 17 seconds for MONO and LP2 mode, and 33 seconds for LP4 mode.

When search operation is performed, the sound breaks up.

When searching on tracks created through editing operations, the sound will sometimes break up.

When dubbing from CD to MD, space is created between tracks.

In order to properly record the cueing positions between tracks, space of a certain length is created. If such spaces between tracks are not desired, make the following settings before dubbing.

- Connect the CD digital output to the MD digital input (either the optical or the coaxial terminal)
- Select OPTICAL or COAXIAL as the input source
- In the REC sub-menu of the MD menu, set the SYNC MODE option to ON

Track numbers are not properly entered.

When recording a CD through a digital connection, short tracks are sometimes created depending upon the recorded content of the CD. Also, when the Auto Track function is used and track numbers are automatically generated, depending upon the program material, the track numbers are not properly assigned.

The TOC Reading indication stays on for a longer time.

When a new recordable MD disc is used, the TOC Reading indication is displayed longer than usual.

For title input, less than 1,700 characters are available.

The title recording area is divided into 7-character units. Even if a title is created with less than 7 characters, that amount of space is still taken up. Therefore, in actual use, you may not be able to input a total of 1,700 characters.

16 – Messages and Troubleshooting

■ Operation messages

| Message | Details/response |
|--------------|---|
| Blank Disc | A blank recordable MD disc has been inserted. |
| Complete | Editing operation has been successfully completed. |
| Dubbing Wait | The unit is being readied for dubbing. |
| TOC Reading | The table of contents data is being read. |
| UTOC Writing | The user table of contents data is being written to the disc. |
| Now Editing | Editing operation is being performed. |
| Over Write | Overwrite recording mode is on. |

■ Warning messages

| Message | Details/response |
|------------|--|
| Key Locked | The entire panel is locked. To release the lock, press and hold the TIME and DISPLAY buttons simultaneously. |
| CD Locked | The deck is locked. To release the lock, select none under PANEL LOCK? |
| MD Locked | in the SYSTEM submenu of the CD Eject Locked menu. |

■ Error Messages

| Message | Details/response |
|--------------|---|
| Disc Error! | The disc has malfunctioned. Please replace with a new disc. |
| Disc Full! | No recording time remaining on the disc, so new recording is not possible. |
| Title Full! | No more titles can be recorded. |
| D-IN UNLOCK! | Digital signals are not correctly input. This message appears if the selected input source (coaxial or optical) does not correspond to the connected terminal or the connected device is powered off. Select the input source correctly, or turn on the connected device. |
| Not Execute! | Editing cannot be completed due to MD system limitations. |
| Not Audio! | There is no audio signal from DIGITAL INPUT . |
| No Track! | There are no recorded tracks. |
| PGM Empty! | There is no program |
| PGM Full! | No new programs can be created. |
| W Protected! | Write-protected MD disc, so recording or editing is not possible. |
| Pre Master! | A playback-only MD disc has been inserted. |
| TOC Error! | TOC data is not correct. |
| Can't Edit! | Editing cannot be performed due to MD system limitations or editing condition limits. |

| | |
|--------------|--|
| Can't Rec! | Recording cannot start because the Group playback mode is on. |
| Can't Sel! | Menu selection cannot be performed due to selection prohibitions. |
| Can't Undo! | You can't undo since no editing has been done. |
| Rec Error! | There was an error during recording. Please re-record. |
| Drive Error! | There is a problem in the drive. |
| Sync Rec ON! | The Sync mode is on, so the recording cannot be started manually. |
| Err Group! | There is a problem in the data of the created group. |
| No Group! | No groups have been created. |
| No DIR! | The directory where the file is has not been registered. |
| Decode Err! | The MP3 file cannot be played back. |
| IR Disable! | All remote control operations are disabled. |
| Format Err! | The unit does not support the format of the MP3 files on the disc. |

■ Troubleshooting

There is no power to the unit.

Please check that the power cord is properly plugged in.

Disc Error! is displayed.

The disc may be dirty. Please replace the disc.

Playback is not possible.

This may be due to condensation. In this case, remove the disc, turn the power on and wait a few hours, then try again.

No sound is output.

- Confirm the connections with the audio system.
- Check the volume level, and proper amplifier operation.

Recording isn't possible.

- The MD disc is set to write protect. Slide the tab on the cartridge to the closed position and try again.
- Confirm the connections with the audio system.
- Adjust the recording level.
- The disc may be for playback only. Please replace it with a recordable MD disc.
- Remaining recording time on the MD is insufficient. Please delete unwanted tracks or replace the MD disc.
- Confirm amplifier operation.

Noise or static can be heard.

Please re-position the unit away from strong sources of magnetism such as a television.

The MD-CD1MKIII does not retain settings.

While settings are retained each time they are made, in some cases they will not be retained when the power is turned off too soon. To prevent this from happening, do not turn off the power right after making a setting.

MD deck

Type

MiniDisc recorder

Discs

MiniDisc format

Number of channels

2 channels (stereo)/1 channel (mono)

Rec modes

Stereo/Mono/LP2/LP4

Recording format

Magnetic field modulation overwrite

Recording time

| | Standard (stereo) | Mono | LP2 | LP4 |
|----------------|-------------------|------|-----|-----|
| 60-minute disc | 60 | 120 | 120 | 240 |
| 74-minute disc | 74 | 148 | 148 | 296 |
| 80-minute disc | 80 | 160 | 160 | 320 |

Sampling frequency

44.1 kHz

Compression system

ATRAC (Adaptive Transform Acoustic Coding)

CD deck

Type

Compact Disc player

Discs

CD-DA (12 cm/8 cm), CD-ROM (12 cm/8 cm), CD/CD-R/CD-RW

File system

ISO9660 LEVEL 1/2/ROMEO/JOLIET format

Formats

Audio CD (CD-DA), MPEG Audio Layer III (MP3), WAV

Audio CD playback specifications

Sampling frequency: 44.1 kHz

Quantization bit rate: 16 bit

Number of channels: 2

MP3 playback specifications

Audio modes: STEREO, JOINT STEREO, DUAL CHANNEL, MONO

Sampling frequency: 44.1 kHz

Bit rate: 32 kbps - 320 kbps, or VBR

WAV playback specifications

Sampling frequency: 44.1 kHz

Quantization bit rate: 16 bit

Input ratings (MD inputs)

Analog inputs (Unbalanced)

Connector: RCA pin jack

Input impedance: 22 k Ω

Nominal input level: -10 dBV (0.32 Vrms)

Maximum input level: +6 dBV (2.0 Vrms)

Minimum input level: -22 dBV (0.08 Vrms)

Digital inputs (Coaxial)

Connector: RCA pin jack

Format: IEC-60958-3 (S/PDIF, conforming to SCMS)

Sampling frequency range: 32 kHz - 48 kHz

Digital inputs (Optical)

Connector: TOS (JEITA RC-5720C)

Format: IEC-60958-3 (S/PDIF, conforming to SCMS)

Output ratings

Analog outputs (Unbalanced)

Connector: RCA pin jack

Output impedance: 200 Ω

Nominal output level: -10 dBV (0.32 Vrms)

Maximum output level: +6 dBV (2.0 Vrms)

Headphone outputs

Connector: 6.3 mm stereo standard jack.

Maximum output: 20 mW + 20 mW (1 kHz, 0.1%, 32 Ω)

Digital outputs (Coaxial)

Connector: RCA pin jack

Compatible signal format: IEC-60958-3 (S/PDIF, conforming to SCMS)

Digital outputs (Optical)

Connector: TOS (JEITA RC-5720C)

Format: IEC-60958-3 (S/PDIF, conforming to SCMS)

17 – Specifications

Control I/O

RS-232C

Communication specifications: Conforming to RS-232C protocol 1.00 specifications
Connector: D-Sub 9-pin connector

Keyboard (for PS/2 keyboard connection)

Connector* Mini DIN connector

Audio performance

Frequency response

20 Hz - 20 kHz ± 0.5 dB (CD playback, JEITA)
20 Hz - 20 kHz ± 0.5 dB (MD playback, JEITA)
20 Hz - 20 kHz ± 0.5 dB (MD recording/playback, JEITA)

S/N ratio

100 dB or more (CD playback, JEITA)
98 dB or more (MD playback, JEITA)
95 dB or more (MD recording/playback, JEITA)

Total harmonic distortion

0.004% or less (CD playback, JEITA)
0.004% or less (MD playback, JEITA)
0.006% or less (MD recording/playback, JEITA)

Dynamic range

100 dB or more (CD playback, JEITA)
98 dB or more (MD playback, JEITA)
95 dB or more (MD recording/playback, JEITA)

Channel separation

90 dB or more (CD playback, JEITA)
90 dB or more (MD playback, JEITA)
83 dB or more (MD recording/playback, JEITA)

General

Power

USA/Canada: 120 VAC, 60 Hz
U.K./Europe: 230 VAC, 50 Hz
Australia: 240 VAC, 50 Hz

Power consumption

USA/Canada: 22 W
U.K./Europe/Australia: 24 W

External dimensions (W x H x D)

483 x 94 x 308 mm

19 x 3.7 x 12.1 in.

Weight

5.4 kg/11.9 lbs

Operation temperature range

5-40°C

Inclination of installation

5° or less

Dimensional drawing

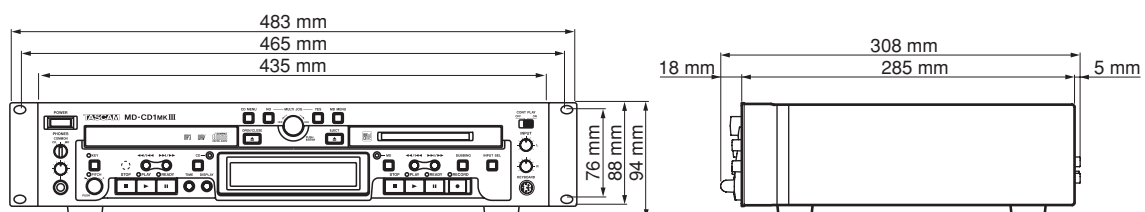

- Illustrations in this manual may differ in part from the actual product.
- Specifications and the external appearance may be changed without notification to improve the product.

TASCAM

MD-CD1MKIII

TEAC CORPORATION

Phone: +81-42-356-9143

1-47 Ochiai, Tama-shi, Tokyo 206-8530, Japan

<http://tascam.jp/>

TEAC AMERICA, INC.

Phone: +1-323-726-0303

7733 Telegraph Road, Montebello, California 90640 USA

<http://tascam.com/>

TEAC CANADA LTD.

Phone: +1905-890-8008 Facsimile: +1905-890-9888

5939 Wallace Street, Mississauga, Ontario L4Z 1Z8, Canada

<http://tascam.com/>

TEAC MEXICO, S.A. de C.V.

Phone: +52-55-5010-6000

Río Churubusco 364, Colonia Del Carmen, Delegación Coyoacán, CP 04100, México DF, México

<http://www.teacmexico.net/>

TEAC UK LIMITED

Phone: +44-8451-302511

Suites 19 & 20, Building 6, Croxley Green Business Park, Hatters Lane, Watford, Hertfordshire, WD18 8TE, UK

<http://www.tascam.co.uk/>

TEAC EUROPE GmbH

Phone: +49-611-71580

Bahnstrasse 12, 65205 Wiesbaden-Erbenheim, Germany

<http://tascam.de/>